



Smarter Tools for  
Smarter Work

## Tube Cleaning Equipment, Accessories, and Supplies



Tools for cleaning tubes in...

**HEAT EXCHANGERS**

**FIRE TUBE AND  
WATER TUBE BOILERS**

**CONDENSERS, CHILLERS,  
AND ABSORBERS**

*and other tubular structures  
and pressure vessels*

**Thomas C. Wilson, Inc.**

# The right tools for the job

To place orders call Toll Free (800) 230-2636 or fax (718) 361-2872

## Thomas C. Wilson, Inc.

### Wilson...

#### A Family Tradition

Thomas C. Wilson, Inc. was founded by my grandfather in 1925. The company originally developed a line of air, water, and electrically driven tube cleaners which, with improvements from time to time to keep abreast of advances in metallurgy and tubular apparatus design, remains unsurpassed to the present day. These tools and other Wilson tools and accessories are now sold to the process, power, HVAC, OEM manufacturer, boiler repair, and commercial markets, both domestically and abroad.

Our engineering department is continually updating our current products and developing new ones to help increase the efficiency of those working to build, repair, and maintain heat exchangers, boilers, condensers, chillers/absorbers, and similar pressure vessel products.

Our success through the years has been a direct result of our commitment to outstanding customer service. From our service hotline to our money back guarantee, we are committed to ensuring not only the quality of our products, but also the complete satisfaction of you, our customer.

Sincerely,



Stephen Hanley  
Chief Operating  
Officer & President



#### Service Hotline

If you have technical questions about tube cleaning and expanding, or any Thomas C. Wilson, Inc. product, call us toll free at (800) 230-2636 and talk to a knowledgeable Thomas C. Wilson, Inc. representative.

**There is a Thomas C. Wilson, Inc. representative or distributor in every major city, domestically and internationally. Please write, call, or fax us to locate your area representative.**

#### Customer Satisfaction/Money Back Guarantee

If, for any reason, you are not satisfied with your purchase, simply return it to us within 10 days, and we will refund the purchase price of the unit, exclusive of shipping and handling costs.

#### One Year Limited Warranty

All Thomas C. Wilson, Inc. products are manufactured, tested, and inspected in accordance with strict engineering requirements and are warranted to be free from defects in materials and workmanship.\*

#### Delivery

Thomas C. Wilson, Inc. products are delivered by all major common carriers, and next day delivery is available. We also have same day, counter-to-counter delivery on request.

#### What's On Your Mind

We're always interested in your comments! At Thomas C. Wilson Inc., we work every day to improve our product offerings and customer service. We want to know what you think. Please write, call, or fax us with your comments or suggestions, or reach us online at <http://www.tcwilson.com>.

**THOMAS C. WILSON, INC. MAIN FACILITY:**  
21-11 44th Avenue • Long Island City, NY 11101-5088 USA  
(800) 230-2636 • (718) 729-3360  
fax: (718) 361-2872 • e-mail: [tcwilson@tcwilson.com](mailto:tcwilson@tcwilson.com).



### How to Order



Our sales engineers are available Monday - Friday, 8:30am to 6:30pm EST. The easiest way to order is to look up the product that you would like to purchase and note the corresponding part number. Then, call toll free (800) 230-2636. If you are not sure exactly what tool you need, just give our experienced staff the details and they will help you find the right product for your application.

**You can use your Visa, Mastercard, or American Express card to order.**

\* There is a minimum order of \$50.

All Thomas C. Wilson, Inc. products are designed and manufactured in the U.S.A.

\* The warranty is subject to conditions and limitations. Call for details.

**24 HOUR SERVICE**  
365 days a year... **Call 1-800-230-2636**

# Table of Contents

# Product Locator

**Ordering Information** .....Page 2

## Kits for Cleaning Heat Exchangers, Condensers and Other Small Diameter Pressure Vessels

- Wils-Away™** Electric Tube Cleaning Kits .....Page 4  
*(3/8 to 1½-Inch OD Tubes)*
- Wils-Matic™** Auto Tube Puncher Kits .....Page 6  
*(5/8 to 1-Inch OD Tubes)*
- MS Series** Air-Driven Tube Cleaning Kits .....Page 8  
*(5/8 to 2-Inch OD Tubes)*
- Blo Gun** Air/Water Driven Tube Cleaning Kits .....Page 10  
*(3/8 to 1-Inch OD Tubes)*
- Wils-Away™** Pneumatic Tube Cleaning Kits .....Page 11  
*(3/8 to 1½-Inch OD Tubes)*
- PG Series** Air-Driven Tube Cleaning Kits .....Page 12  
*(1/4 to 1¼-Inch OD Tubes)*
- TP-302** Air-Driven Tube Cleaning Kits .....Page 14  
*(3/4 to 2½-Inch OD Tubes)*

## Kits for Cleaning Fire Tube and Water Tube Boilers, and Other Large Diameter Pressure Vessels

- Wils-Away™** Electric Tube Cleaning Kits .....Page 16  
*(1½ to 4½-Inch OD Tubes/Fire Tube Boilers)*
- Vacuum Cleaners and Accessories** .....Page 18  
*(Fire Tube Boilers)*
- FT Series** Air-Driven Tube Cleaning Kits .....Page 19  
*(2 to 4½-Inch OD Tubes/Fire Tube Boilers)*
- C Series** Air-Driven Tube Cleaning Kits .....Page 20  
*(1 to 2½-Inch OD Tubes/Water Tube Boilers)*
- ECT Series** Air-Driven Tube Cleaning Kits .....Page 22  
*(2½ to 7½-Inch OD Tubes/Water Tube Boilers)*
- Plant Manager's Kit** .....Page 23  
*(3/8 to 4½-Inch Boilers AND Heat Exchangers)*
- EP Series** Air-Driven Tube Cleaning Kits .....Page 24  
*(1½ to 6½-Inch Boilers and Large Diameter Pressure Vessels)*

**Kits:** To order a tube cleaning kit from this catalog, first determine the tube Inner Diameter (ID) beyond the expanded area of the tube within the tubesheet. If you do not know the tube Inner Diameter, use the **Tube ID Smart Chart** on page 42 and charts on Page 52, 53 and 54.

**Cleaning Heads:** Use the **Smart Tube Cleaning** chart on Page 26 to select the best cleaning head for your application.

## Cleaning Heads

- Smart Tube Cleaning** .....Page 26
- Spiral, Spin Grit and Spin Clean Brushes .....Page 27
- Buffing Tools .....Page 27
- Expanding Brushes, Expanding Scrapers .....Page 28
- Spiral and Soot Brushes,  
U-Bend Cleaning Assemblies,  
Manual Tube Cleaning Rods and Handles .....Page 30
- Shafts & Casings, Wils-Away™ Accessories .....Page 31
- Model A and Model B Cutter Heads,  
Universal Joints .....Page 32
- Cone Cutters, Cutter Wheels,  
Type C Flexible Holders, Drill Heads .....Page 33
- Model SE Cutter Heads .....Page 34
- Model R Cutter Heads .....Page 35
- Model CHJ Cutter Heads .....Page 36
- Model CHJ Cutter Heads (Curved Tubes) .....Page 37
- Swing Frame Brushes .....Page 37
- P Brushes, SPE-DUR/M/K Cutter Bits .....Page 38
- PG, PGX-2, TP-302 Accessories .....Page 39
- Universal Expanding Brushes,  
Type SC Flexible Holders, Sectional Brushes ....Page 40

## Accessories

- Type HF, MF, MM and FF Adapters .....Page 41
- Air and Water Hoses .....Page 42
- Pneumatic Accessories .....Page 43
- Flo-Breaker .....Page 50

## Motor Specification and Parts

- EP Series Air Motors .....Page 44
- MS, C and ECT Series Air Motors .....Page 46
- Blo Gun and PG Series Air Motors .....Page 48
- PGX-2 and TP-302 Series Air Motors .....Page 49

## Charts

- Smart Tube Cleaning .....Page 26
- Curved Tube Data .....Page 40
- Tube ID Smart Chart .....Page 42
- Boiler and Condenser Tube Sizes: Inches .....Page 52
- Boiler and Condenser Tube Sizes: Millimeters .....Page 53
- American Standard Welded and  
Seamless Steel Pipe .....Page 54
- Millimeter/Inch and Decimal/Fraction Conversions ..Page 54

## Special Application Cleaning Kits

- Gas Line Renewal, Aerco Water Heater and  
Catalyst Cleaning Kits .....Page 51

Illustrations for this catalog were supplied by American Precision, Babcock & Wilcox and Yuba.



# Heat Exchangers/Condensers

## Wils-Away™ Electric Tube Cleaning System



### Applications

- Cleaning Straight and Curved Tubes in Heat Exchangers, Condensers, Chillers, Absorbers, Water Heaters, Coolers, and Other Small Diameter Pressure Vessels
- 3/8 – 1½-Inch (9.5 to 38.1mm) Outer Diameter Tubes
- Removing Light to Medium Soft Deposits

### Specifications

- Dolly-Mounted  
 Drive Unit: 55 lbs.; 12" H x 23" W x 11½" D (25Kg; 305 x 584 x 292mm)
- Compact Drive Unit: 35 lbs.; 10" H x 18" W x 8½" D (16Kg; 254 x 457 x 216mm)
- Speed: 1,725 rpm  
 Power: 1/2 HP (WAW-500 Series)  
 1 HP (WAW-1000 Series)



### Wils-Away™ Kit Includes:

- Electric Drive Unit (either Dolly-Mounted or Compact Unit)
- Foot Pedal-Single Direction
- Spare Safety Shaft Coupling (WAW-500 Series *only*)
- 25-Foot Shaft & Casing (7.6M)
- Set of 6 Nylon Spiral Brushes
- or-
- Expanding Bronze Brush and Spare Refill Set
- Service Manual SM-223 (WAW500, 1000) SM-244 (WAW-520)

Twin foot pedal (for remote forward/reverse control) is an optional accessory. (Page 31)



Tube ID Range		Complete Kit†	consists of	Drive Unit	- and - Flexible Shaft & Casing	- and - 6 Nylon <sup>1</sup> Spiral Brushes	- or - Expanding <sup>2</sup> Bronze Brush
Inches	(mm)						
.281 - .311	(7.1 - 7.9)	WAW-500 (Dolly-Mounted) - or - WAW-520 (Compact Unit) 115V 50/60 Hz		9600	9720-0015 (8 x 32 Female Thread)	61746-4025	-
.312 - .342	(7.9 - 8.7)					61746-4028	-
.343 - .374	(8.7 - 9.5)					61746-4031	-
.375 - .405	(9.5 - 10.3)					61746-4034	-
.406 - .436	(10.3 - 11.1)					62501-4037	-
.437 - .499	(11.1 - 12.7)					62501-4043	-
.500 - .561	(12.7 - 14.2)					62501-4050	-
.562 - .624	(14.2 - 15.8)			9506	9722-0025 (1/4 x 28 Female Thread)	62501-4056	9900-3003
.625 - .686	(15.9 - 17.4)					62501-4062	9900-3006
.687 - .749	(17.4 - 19.0)					62501-4068	2456-3002 <sup>3</sup>
.750 - .811	(19.0 - 20.6)					62501-4075	2456-3003 <sup>3</sup>
.812 - .874	(20.6 - 22.2)					62501-4081	2456-3004 <sup>3</sup>
.875 - .936	(22.2 - 23.8)					62501-4087	2456-3006 <sup>3</sup>
.937 - .999	(23.8 - 25.4)					62501-4093	2463-3004 <sup>3</sup>
1.000 - 1.061	(25.4 - 26.9)	9610	9724-0025 (1/4 x 28 Female Thread)	62501-4100	2463-3005 <sup>3</sup>		
1.062 - 1.124	(26.9 - 28.5)			-	2463-3007 <sup>4</sup>		
1.125 - 1.186	(28.5 - 30.1)			-	2463-3008 <sup>4</sup>		
1.187 - 1.249	(30.1 - 31.4)			-	2470-3002 <sup>4</sup>		
					9728-0025 (9/16 x 12 Male Thread)		

Product Details

Page 31

Page 27

Page 28

† For other than 115V 50/60Hz units, order **WAW-510** (220V 50/60Hz), **WAW-530** (115V 50Hz), **WAW-540** (220V 60Hz), **WAW-550** (220V 50Hz), or **WAW-1100** (220V 50/60Hz).

1. For steel spiral brushes, change the last four digits of the Part No. to "0XXX", for stainless steel "2XXX", for brass "3XXX".

2. For expanding brush with nylon bristles, change the last four digits to "4XXX", for stainless steel "5XXX", for steel "0XXX".

3. These expanding brushes require an adapter (Part No. 9589).

4. These expanding brushes require an adapter (Part No. 9798).



**Smart Tool**

- Runs wet or dry. When run wet, water aids cleaning action, flushing away scale. When water is clear, the tube is clean!
- Operates both forward and reverse with twin foot pedal.
- Simultaneous foot-controlled activation of motor direction and water flushing enable one-man operation.
- Available as either dolly-mounted or compact easy-to-carry unit. Both units include storage compartment for accessories.

**Safety Shaft Coupling:**

WAW-500 Series drive units are equipped with a safety shaft coupling that snaps under accidental overload, protecting the shaft from breakage. A spare coupling and removal tool are supplied with each kit.

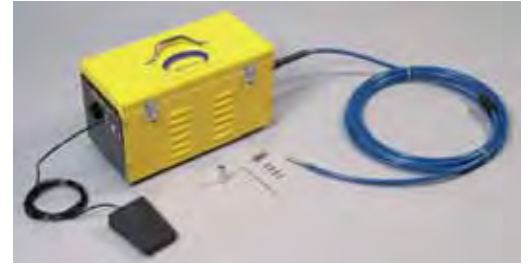

**Accessories**



Spin Grit Brush	Spin Clean Brush	SPE-DUR Cutter Bit with Adapter	Buffing Tool with Drill Tip	Expanding Scraper	Model A Cutter Head	U-Bend Cleaning Assembly
62551-0050		-	-			
		-	62622-0005			
		-	62622-0006			
62551-0075	62615-0075	7162-9949	62622-0006	2569-9587	7211-9662	62690-5000 (Brass Cup Brush Type)
		7163-9949	-	2575-9587		
62551-0100	62615-0100	7163-9672	62622-0007	3055-9589	7212-9662	62660-0075 (Stainless Steel Wheel Brush Type)
		7164-9664	62622-0010	2578-9589	7213-9795	
62551-0125	62615-0112	7165-9950		62626-6759	2586-9589	7218-9791
			7166-9950		2592-9589	7215-9665
	62615-0175	7167-9666	-	2600-9589	7216-9665	62660-0100 (Stainless Steel Wheel Brush Type)
		7168-9666		2606-9798	7217-4387	
		7169-9666			7282-4385	
		7170-9667				
		7171-9667				
		7172-9667				
		7173-4386				
		7778-4386				
		7792-4386				

Page 27

Page 27

Page 38

Page 27

Page 28

Page 32

Page 30



# Heat Exchangers/Condensers

## Wils-Matic™ Auto Tube Puncher



### Applications

- Cleaning Straight Tubes in Heat Exchangers, Condensers, Chillers, Absorbers, Water Heaters, Coolers and Other Small Diameter Pressure Vessels
- 1/2 – 1¼-Inch (15.9 to 31.8 mm) Outer Diameter Tubes
- Removing Light to Medium Soft Deposits

### Specifications

- Dolly Mounted
- Drive Unit: 85 lbs.; 42" H x 30" W x 16" D (38kg, 1067 x 762 x 406 mm) (excluding Gun Assembly and Shaft)
- Shaft Speed 1,725 rpm
- Shaft Feed Rate 4.2 feet (1.3M) per second
- Feed Force 60 lbs. (267N)
- Motor Power 1 HP (0.75kW)
- Input Power 15 amps
- Voltage/Frequency 115 volt 60 Hz (220 volt 50/60 Hz available)

### Wils-Matic Kit Includes

- Electronic Drive Unit with portable dolly
- Feeder Gun Assembly
- Feeder Gun Safety Harness
- Shaft & Casing - 45 feet
- Shaft Length Stop unit
- Service Manual SM-165

Patent Pending

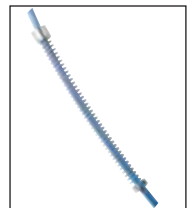

Tube ID Range		Complete Kit*	consists of	Drive Unit	and	Flexible Shaft & Casing†	and	Feeder Gun Assembly & Safety Harness	and	Shaft Length Stop Unit
Inches	(mm)									
.437 - .499	(11.1 - 12.7)	WAM-5500-375		9992-1600		9722-0045 (1/4 x 28 Female Thread)		9992-3105 & 9992-3150		9992-4030
.500 - .561	(12.7 - 14.2)									
.562 - .624	(14.2 - 15.8)	WAM-5500-500		9992-1600		9724-0045 (1/4 x 28 Female Thread)		9992-3105 & 9992-3150		9992-4000
.625 - .686	(15.9 - 17.4)									
.687 - .749	(17.4 - 19.0)									
.750 - .811	(19.0 - 20.6)									
.812 - .874	(20.6 - 22.2)									
.875 - .936	(22.2 - 23.8)									
.937 - .999	(23.8 - 25.4)									
1.000 - 1.061	(25.4 - 26.9)									

Product Details:

Page 31

Page 7

Page 7

\* For 220V 50/60Hz units, order WAM-5520-375 and WAM-5520-500

† Longer length available (see page 31)

# Wils-Matic™ Auto Tube Puncher



### Smart Tool

- Simultaneous hand-controlled activation of motor direction, shaft feed, and water flushing enable one-man operation
- Unique “non-slip” feeding
- Adjustable forward end limit stop
- Quick “plug & play” start up



### How it works

During operation, a feeder gun controls shaft rotation, shaft feed, and the water flow. By just pressing the top of the trigger, you will rotate the shaft clockwise, start water flow, and feed the Shaft & Casing into the tube. By pressing the bottom of the trigger, you will reverse the shaft rotation and pull out the Shaft & Casing from the inside of the tube. The distance to be cleaned is set by an adjustable Shaft & Casing length stop unit, and the shaft feed stops when it reaches the set distance.



Nylon Spiral Brushes	Brush Diameter	
	Inches	(mm)
62501-4043	7/16	(11.1)
62501-4050	1/2	(12.7)
62501-4056	9/16	(14.3)
62501-4062	5/8	(15.9)
62501-4068	11/16	(17.5)
62501-4075	3/4	(19.1)
62501-4081	13/16	(20.6)
62501-4087	7/8	(22.2)
62501-4093	15/16	(23.8)
62501-4100	1	(25.4)

Page 27



Spin Grit Brush	Brush Diameter	
	Inches	(mm)
62551-0062	5/8	(15.9)
62551-0075	3/4	(19.1)
62551-0100	1	(25.4)
62551-0125	1 1/8	(28.6)

Page 27



Spin Clean Brush	Brush Diameter	
	Small	Large
62615-0075	.500	.750
62615-0100	.625	1.000
62615-0112	.750	1.125
62615-0175	1.000	1.375

Page 27

# Heat Exchangers/Condensers

## MS Series Air-Driven Tube Cleaning System



### Applications

- Cleaning Straight Tubes in Heat Exchangers, Condensers, Chillers, Absorbers, Small Diameter Boilers, and Other Pressure Vessels under 2 Inches Outer Diameter Pipelines
- 5/8 – 2-Inch (15.9 to 50.8mm) Outer Diameter Tubes
- Removing Light to Moderate Scale

### Specifications

- Speed: 8,000 to 10,000 rpm
- Air: 80 to 125 psi
- Motor: Steel rotor blades and precision ground surfaces result in high-performance and durability

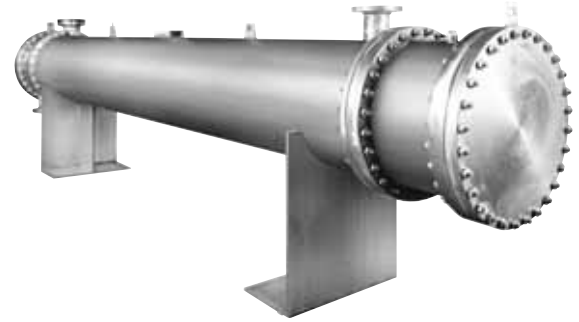

Shell and Tube Heat Exchanger

### MS Series Kit Includes:

- MS Air Motor
- Type C Flexible Holder
- Expanding Steel Brush with Spare Refill Set
- Model A Cutter Head with 4 Spare Sets of Cutters
- 25-Foot Air Line with Couplings
- Spare Set of Rotor Blades and Wrench
- Tool Box
- Service Manual SM-149



Tube ID Range		Complete Kit	consists of Air Motor	- and - Type C Flexible Holder	- and - Expanding Steel Brush	- and - Model A Cutter Head	- and - Air Hose Part No.	Inches	Motor Diam.		CFM
Inches	(mm)								Inches	(mm)	
.500 - .624	(12.7 - 15.8)	MS-0	2996	2261	7000-0001	7211	9388-0025	3/16	15/32	(11.9)	9
.625 - .749	(15.9 - 19.0)	MS-1	3002		7000-0005	7212			9/16	(14.3)	10
.750 - .780	(19.0 - 19.8)	MS-1A	3050	2265	2456-0002	7213	7040-0025	1/4	11/16	(17.5)	12
.781 - .874	(19.8 - 22.2)	MS-1B			2456-0003				7215	49/64	(19.4)
.875 - .999	(22.2 - 25.4)	MS-3	8984	2279	2456-0004	7215	8971-0025	3/8	7/8	(22.2)	18
1.000 - 1.124	(25.4 - 28.5)	MS-4	8987		2463-0003	7216			31/32	(24.6)	25
1.125 - 1.217	(28.5 - 30.9)	MS-5	8989	2285	2463-0007	7217	8971-0025	3/8	1 1/2	(27.8)	30
1.218 - 1.311	(31.0 - 33.3)	MS-6	8992		2470-0002	7282			1 1/2	(27.8)	30
1.312 - 1.499	(33.3 - 38.1)	MS-7	8997	2296	2477-0001	5788	8972-0025	3/8	1 7/8	(32.1)	35
1.500 - 1.749	(38.1 - 44.4)	MS-8			2477-0005	5183			1 7/8	(32.1)	35
1.750 - 1.875	(44.4 - 47.6)	MS-10	8999		2484-0006	7231			1 5/8	(39.9)	40

Product Details:

Page 46

Page 33

Page 28

Page 32

Page 42





**Smart Tool**

- Complete kit includes air motor, all required accessories, spare parts, air hose, and tools required for a thorough tube cleaning job.
- Powerful 10,000 rpm air motor cleans in one pass, saving time and improving productivity.
- Kit includes two cleaning heads: expanding brush quickly and efficiently removes light deposits while Model A Cutter Head cuts through harder scale.
- Minimal moving parts improve reliability and durability.
- Kit includes spare rotor blades and wrench, as well as air hose.

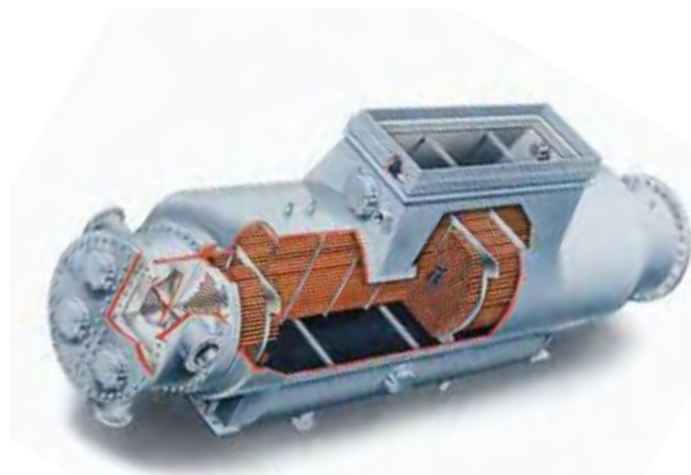

Surface Condenser

**Accessories**



Expanding Scraper	Model B Cutter Head	Buffing Tool	Buffing Tool with Drill Tip	Model M Cutter Bit	Air Valve	Air Line Lubricator	Kit Weight (Less Options)	
							Pounds	(Kg)
2569	8061	-	-	7771-4141	-	52035	4%	(1.9)
2575	8062	62624-9010	62622-9010	7772-4142	-		4%	(2.2)
3055	8063	62624-8010	62622-8010	7774-4143	-		5%	(2.4)
2578				7775-4143	-		5%	(2.6)
2586	8065	62624-7010	62622-7010	7776-4144	-		6	(2.7)
2592	8066			7777-4144	-	7½	(3.4)	
2600	8067	62625-4140	62626-4140	7778-4145	8774	52399	8	(3.6)
2606	8068			7779-4146			12½	(5.7)
2625	8069	62625-9395	62626-9395	7793-4146			13	(5.9)
2617	8070			7795-4147			14%	(6.4)
2634	8071			-			16	(7.3)

Page 28

Page 32

Page 27

Page 27

Page 38

Page 43

Page 43

## Blo-Gun Air/Water Actuated Tube Cleaning System



### Applications

- Cleaning Tubes in Heat Exchangers, Condensers, Chillers, Absorbers, Water Heaters, Coolers, and Other Small Diameter Pressure Vessels
- 3/8 – 1-Inch (9.5 to 25.4mm) Outer Diameter Tubes
- Removing Light to Medium Soft Deposits
- Ideal for Removing Soft Mud or Marine Growth that is Typical in Steam Condensers, Chillers, and Absorbers

### Smart Tool

- Fastest method for cleaning tubes. *Ideal when time is critical and there is a large number of tubes to clean!*
- Lightweight tool minimizes user fatigue, and Blo-Gun can be used anywhere.
- Re-usable Blo-Plugs or Blo-Brushes are economical.
- Can be powered by compressed air or water.
- Safety shield protects operator.
- No trigger: just push forward to activate!

### Blo-Gun Kit Includes

- Blo-Gun with Spare Shield
- Package of 25 Blo-Plugs
- Package of 6 Blo-Brushes
- Air/Water Hose
- Tool Box
- Service Manual SM-16



Tube ID Range Inches (mm)	Complete Kit	consists of	Blo-Gun	Blo-Plugs (Pckg of 25)		Blo-Brushes (Pkg of 6)		Spare Shield	Air/Water Hose
				Part No.	Diam.	Part No.	Diam.		
.287 - .314 (7.3 - 8.0)	BG	8044		8296-0018	.402	9642-0018	.287	8086	8973-0025 (1/2 Inch)
.315 - .328 (8.0 - 8.3)						9642-0020	.315		
.329 - .369 (8.3 - 9.4)						9642-0022	.329		
.402 - .429 (10.2 - 10.9)				8296-0020	.430	8301-0018	.412		
.430 - .443 (10.9 - 11.3)				8296-0022	.444	8301-0020	.440		
.444 - .458 (11.3 - 11.6)				8297-0018	.527	8301-0022	.454		
.527 - .540 (13.4 - 13.7)				8297-0019	.541	8302-0018	.550		
.541 - .554 (13.7 - 14.1)				8297-0020	.555	8302-0019	.565		
.555 - .568 (14.1 - 14.4)				8297-0022	.569	8302-0020	.580		
.569 - .583 (14.4 - 14.8)				8298-0018	.652	8302-0022	.594		
.652 - .679 (16.5 - 17.2)				8298-0020	.680	8303-0018	.677		
.680 - .693 (17.2 - 17.6)				8298-0022	.694	8303-0020	.705		
.694 - .708 (17.6 - 18.0)				8299-0018	.777	8303-0022	.719		
.777 - .804 (19.7 - 20.4)				8299-0020	.805	8304-0018	.807		
.805 - .818 (20.4 - 20.8)				8299-0022	.819	8304-0020	.835		
.819 - .833 (20.8 - 21.2)				8299-0022	.819	8304-0022	.849		
.902 - .929 (22.9 - 23.6)	8300-0018	.902	8305-0018	.935					
.930 - .943 (23.6 - 24.0)	8300-0020	.930	8305-0020	.961					
.944 - .958 (24.0 - 24.3)	8300-0022	.944	8305-0020	.975					

### Accessories

Product Details:

Page 48

Page 42



Nozzle Extension

Description	Part No.
18-Inch Nozzle Extension	8471-0018
24-Inch Nozzle Extension	8471-0024
30-Inch Nozzle Extension	8471-0030
Service Manual	SM-16
Tool Box	6404-0002



Dowel Brush

Tube ID Range Inches (mm)	Dowel Brush	Brush Diam.
.652 - .665 (16.6 - 16.9)	62728-0018	.662
.666 - .679 (16.9 - 17.3)	62728-0019	.676
.680 - .693 (17.3 - 17.6)	62728-0020	.690
.694 - .707 (17.6 - 18.0)	62728-0022	.704
.777 - .790 (19.7 - 20.1)	62729-0018	.787
.791 - .804 (20.1 - 20.4)	62729-0019	.801
.805 - .818 (20.4 - 20.8)	62729-0020	.815
.819 - .832 (20.8 - 21.1)	62729-0022	.829
.902 - .915 (22.9 - 23.3)	62730-0018	.912
.916 - .929 (23.3 - 23.6)	62730-0019	.926
.930 - .943 (23.6 - 24.0)	62730-0020	.940
.944 - .957 (24.0 - 24.3)	62730-0022	.954



# Wils-Away™ Pneumatic Tube Cleaning System



## Applications

- Cleaning Tubes in Heat Exchangers, Condensers, Chillers, Absorbers, Water Heaters, Coolers, and Other Small Diameter Pressure Vessels
- 3/8 – 1½-Inch (9.5 to 38.1mm) Outer Diameter Tubes
- Removing Medium to Hard Deposits
- Ideal Cleaning System when Electric Power is Not Available
- Air Motor Enables Operator to Control Speed of Cleaning Head and Shaft & Casing Rotation

## Specifications

- Dolly-Mounted**  
 Drive Unit: 58 lbs.; 12" H x 23" W x 11½" D (26Kg; 305 x 584 x 292mm)
- Compact Drive Unit:** 32 lbs; 10" H x 18" W x 8½" D (14Kg; 254 x 457 x 216mm)
- Speed: 500 to 3,000 rpm  
 Air Consumption: 15 CFM @90 psi (WAW-3000)  
 40 CFM @90 psi (WAW-4000)
- Power: 1½ HP (WAW-3000)  
 4 HP (WAW-4000)
- Air Hose: 3/8-Inch Minimum  
 1/2-Inch - 50 Feet - **Part No. 9600-0121**

## Smart Tool

- Kit includes drive unit and all accessories required for thorough tube cleaning.
- Spiral brushes clean many tubes in one pass.
- Expanding brush removes heavier deposits.
- Runs wet or dry without lubrication.
- When run wet, water aids cleaning action and flushes away debris. When the water is clear, the tube is clean!
- WAW-3000 offers forward/reverse drive via remote foot pedal.
- Air-activated foot pedal ensures operator safety.

## Wils-Away™ Pneumatic Kit Includes

- Dolly-Mounted or Compact Drive Unit with Tool Compartment
- Flexible Shaft & Casing
- Foot Pedal
- 6 Nylon Spiral Brushes
- or -
- Expanding Bronze Brush and Spare Refill Set
- Service Manual SM-243 (WAW-3000) SM-226 (WAW-4000)

The **WAW-3000** and **WAW-4000** use the same accessories as the **WAW-500-1000** series, so refer to the chart on Page 5 for accessories.

Tube ID Range		Complete Kit <sup>1</sup>	consists of	Drive Unit	- and - Flexible Shaft & Casing	- and - 6 Nylon <sup>1</sup> Spiral Brushes	- or - Expanding <sup>2</sup> Bronze Brush
Inches	(mm)						
.281 - .311	(7.1 - 7.9)	WAW-3000 (1½ HP Compact Unit) -or- WAW-4000 (4 HP Dolly-Mounted Unit)		9502	9720-0015 (8x32 Female Thread)	61746-4025	-
.312 - .342	(7.9 - 8.7)					61746-4028	-
.343 - .374	(8.7 - 9.5)					61746-4031	-
.375 - .405	(9.5 - 10.3)					61746-4034	-
.406 - .436	(10.3 - 11.1)					62501-4037	-
.437 - .499	(11.1 - 12.7)					62501-4043	-
.500 - .561	(12.7 - 14.2)					62501-4050	-
.562 - .624	(14.2 - 15.8)					62501-4056	9900-3003
.625 - .686	(15.9 - 17.4)			62501-4062	9900-3006		
.687 - .749	(17.4 - 19.0)			62501-4068	2456-3002 <sup>3</sup>		
.750 - .811	(19.0 - 20.6)			62501-4075	2456-3003 <sup>3</sup>		
.812 - .874	(20.6 - 22.2)			62501-4081	2456-3004 <sup>3</sup>		
.875 - .936	(22.2 - 23.8)			62501-4087	2456-3006 <sup>3</sup>		
.937 - .999	(23.8 - 25.4)			62501-4093	2463-3004 <sup>3</sup>		
1.000 - 1.061	(25.4 - 26.9)			62501-4100	2463-3005 <sup>3</sup>		
1.062 - 1.124	(26.9 - 28.5)			9728-0025 (9/16x12 Male Thread)	2463-3007 <sup>4</sup>		
1.125 - 1.186	(28.5 - 30.1)	2463-3008 <sup>4</sup>					
1.187 - 1.249	(30.1 - 31.4)	2470-3002 <sup>2</sup>					

Product Details:

Page 31

Page 27

Page 28

1. For steel spiral brushes, change the last four digits of the Part No. to "0XXX", for stainless steel "2XXX", for brass "3XXX".
2. For expanding brush with nylon bristles, change the last four digits to "4XXX", for stainless steel "5XXX", for steel "0XXX".
3. These expanding brushes require an adapter (**Part No. 9589**).
4. These expanding brushes require an adapter (**Part No. 9798**).





### Applications

- Cleaning Tubes in Heat Exchangers, Condensers, Refinery Fixtures, Chillers, Absorbers, Water Heaters, Coolers, Evaporators, and Other Small Diameter Pressure Vessels
- 1/4 – 1½-Inch (6.4 to 31.8 mm) Outer Diameter Tubes
- Removing Heavy Deposits and Cleaning Out Clogged Tubes

### Specifications

Speed: 8,000 to 10,000 rpm

Air: 80 to 125 psi

Motor: Two models cover a wide range of tube sizes

### PG Series Kit Includes:

- PG or PGX-2 Air Motor
- 4 5-Foot Drill Shafts
- 2 M Cutter Bits
- 2 M/SPE-DUR Cutter Bits
- Spare Rotor Blades
- 3/8-Inch Scavenging Hose (15 Feet/4.5M)
- Set of Spare Rotor Blades, Rotor Wrench, and Adjustable Wrench
- Tool Box
- Service Manual SM-22 (PG Series) SM-23 (PGX Series)



Tube ID Range Inches	Tube ID Range (mm)	Complete Kit	consists of	Air Motor	- and -	5-Foot Ext. Shafts (4)	- and -	M Cutter Bits (2)*	- and -	M/SPE-DUR Bit Adapters (2)	Scavenging Hose		
.187 - .205	(4.7 - 5.2)	PG	7005					61242-00XX*			8042-0015 (3/8 Inch)		
.206 - .304	(5.2 - 7.7)							62327-00XX*					
.305 - .318	(7.7 - 8.1)							60605-00XX*					
.319 - .374	(8.1 - 9.5)												
.375 - .437	(9.5 - 11.1)												
.438 - .499	(11.1 - 12.7)	PGX-2	9288					7769					
.500 - .562	(12.7 - 14.3)							6207-0005				7770	7189
.563 - .624	(14.3 - 15.8)							6208-0005				7771	7192
.625 - .686	(15.9 - 17.4)							6209-0005				7786	7194
.687 - .749	(17.4 - 19.0)											7772	
.750 - .811	(19.1 - 20.6)							6210-0005			7773		
.812 - .874	(20.6 - 22.2)										7774	7196	
.875 - .937	(22.2 - 23.8)										7775		
.938 - .968	(23.8 - 24.6)							6211-0005			7776		
.969 - 1.062	(24.6 - 27.0)										7790	7199	
			7777										

Product Details:

Page 48/49

Page 39

Page 38

Page 39

Page 42

\* For Inner Diameter Range .187 - .374 Inches (4.7-9.5mm), a Bit and Shaft Assembly is provided. Insert "24", "36", or "48" as the last two digits of the Part No. to designate the Shaft length that is required.



**Smart Tool**

- Carbide-tipped Type M Cutter Bits literally drill through the heaviest deposits... even totally clogged tubes!
- Cleaning depth is easily increased by adding 5-foot hollow extension shafts.
- Scavenging hose sends water down the extension shafts, cooling the cutter bit and providing flushing action.
- Water flushing clears away debris. When water is clear, the tube is clean!
- Direct drive increases power and minimizes moving parts.



**Accessories**

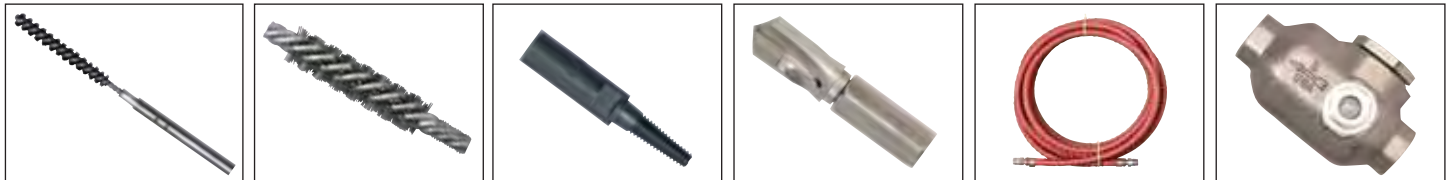

Brush and Shaft Assembly (St. Steel)*	P Brush (Steel)†	P Brush Adapter	SPE-DUR Cutter Bit	Air Hose Part No. Inches	Air Line Lubricator
62280-21XX	62280-0018†			8973-0025 1/2	53360
62430-21XX	62430-0021†				
62432-21XX	61746-0031†				
62433-21XX	61746-0032†				
	8543-0138	9275	7162	8975-0025 3/4 (Armored)	53361
	8543-0143		7163		
	8543-0150	9276	7164		
	8543-0155	9379	7165		
	8544-0162		7166		
	8544-0167		7167		
	8544-0174	9283	7168		
	8544-0182		7169		
	8545-0186		7170		
	8545-0193	9284	7171		
	8545-0196		7172		

Page 39

Page 38

Page 39

Page 38

Page 42

Page 43

\* For Bronze brushes, change last four digits to "31XX", for Nylon "41XX".  
 † For Bronze P Brush, change last four digits to "3XXX", for Nylon "4XXX".

# Heavy-Duty Tube Cleaning

## TP-302 Air-Driven Tube Cleaning System

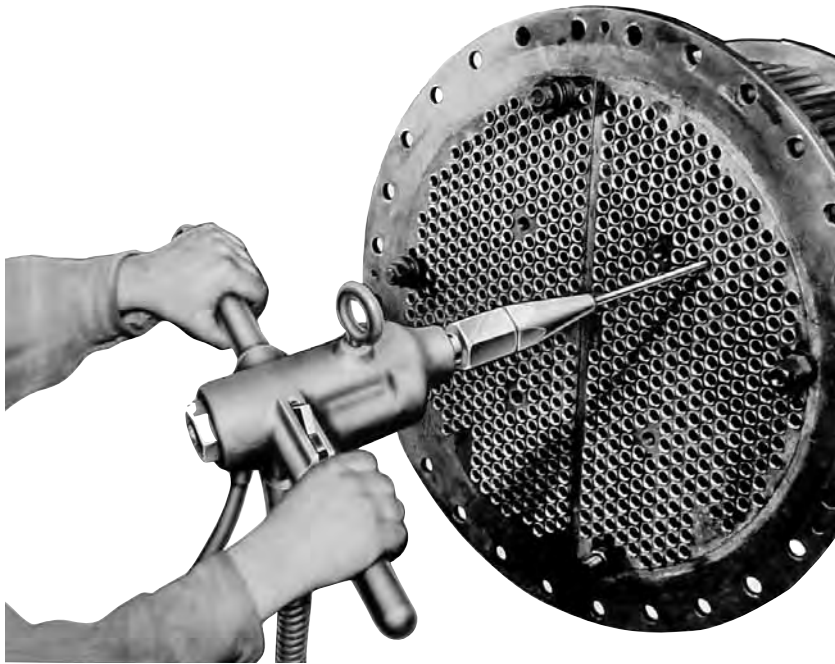

### Applications

- Cleaning Tubes in Heat Exchangers, Condensers, Refinery Fixtures, Chillers, Absorbers, Water Heaters, Coolers, Evaporators, and Other Small Diameter Pressure Vessels
- 3/4 – 2½-Inch (19.1 to 63.5 mm) Outer Diameter Tubes
- Removing Heavy Deposits and Cleaning Out Clogged Tubes

### Specifications

- Speed: 6,800 rpm
- Air: 80 to 125 psi
- Motor: Powerful enough to clean tubes up to 50 feet long

### TP-302 Kit Includes:

- TP-302 Air Motor
- 4 5-Foot Extension Shafts
- 2 M Cutter Bits
- 2 M/SPE-DUR Cutter Bit Adapters
- 3/8-Inch Scavenging Hose (15 Feet/4.5M)
- Trolley (fits 2-Inch pipe)
- Set of Pulley Blocks and 50-Foot Rope
- Set of Spare Rotor Blades, Rotor Wrench, and Adjustable Wrench
- Service Manual SM-135

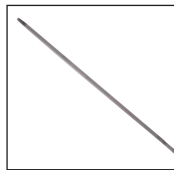

Tube ID Range		Complete Kit	includes	Air Motor	- and -	5-Foot Ext. Shafts (4)	- and -	M Cutter Bits (2)*	- and -	M/SPE-DUR Bit Adapters (2)	- and -	Scavenging Hose									
Inches	(mm)																				
.687 - .749	(17.4 - 19.0)	TP-302		9267 (Air Motor)	- and -	6210-0005	- and -	7773	- and -	7196	- and -	8042-0015 (3/8 Inch)									
.750 - .811	(19.1 - 20.6)							7774													
.812 - .874	(20.6 - 22.2)							7775													
.875 - .937	(22.2 - 23.8)							7776													
.938 - .968	(23.8 - 24.6)							7790													
.969 - .999	(24.6 - 25.4)							7777													
1.000 - 1.062	(25.4 - 27.0)							6211-0005					- and -	4993 (Trolley)	- and -	6212-0005	- and -	7791	- and -	7199	- and -
1.063 - 1.124	(27.0 - 28.5)																	7778			
1.125 - 1.187	(28.6 - 30.1)																	7792			
1.188 - 1.249	(30.2 - 31.7)																	7779			
1.250 - 1.311	(31.8 - 33.3)			7793																	
1.312 - 1.374	(33.3 - 34.9)			7780																	
1.375 - 1.436	(34.9 - 36.5)			7794																	
1.437 - 1.499	(36.5 - 38.1)			7795																	
1.500 - 1.561	(38.1 - 39.6)			7796																	
1.562 - 1.624	(39.7 - 41.2)			7781																	
1.625 - 1.749	(41.3 - 44.4)			6213-0005	- and -	8500 (Muffler)	- and -	- and -	- and -	*	- and -		7203	- and -							
1.750 - 1.874	(44.5 - 47.6)									*											
1.875 - 1.999	(47.6 - 50.8)									*											
2.000 - 2.125	(50.8 - 54.0)									*											

Product Details:

Page 49

Page 39

Page 38

Page 39

Page 42

\* For 1.750 (44.5mm) and larger Inner Diameter tubes, select a Type K Cutter Bit and K Cutter Bit Adapter.





**Smart Tool**

- Carbide-tipped Type M Cutter Bits literally drill through the heaviest deposits... even totally clogged tubes!
- Cleaning depth is easily increased by adding 5-foot hollow extension shafts.
- Scavenging hose sends water down the extension shafts, cooling the cutter bit and providing flushing action. When water is clear, the tube is clean!
- Direct drive increases power and minimizes moving parts.
- Select Type K Cutter Bit for cleaning tubes over 1.750 inches (44.5mm) Inner Diameter. Be sure to also order Wilson K Cutter Bit Adapter.
- Optional SPE-DUR Cutter Bit features negative rake angle. Ideal for breaking through totally clogged tubes.
- After using cutter bit to unclog tube, use P Brush to clean out remaining debris. Be sure to order P Brush adapter.

**Accessories**



SPE-DUR Cutter Bit	P Brush (Steel)	P Brush Adapter	K Cutter Bit	K Cutter Bit Adapter	Armored Air Hose Part No. Inches	Air Line Lubricator
7167	8544-0167	9283	-	-	8976-0025 1	53363
7168	8544-0174		-	-		
7169	8544-0182		-	-		
7170	8545-0186	9284	-	-		
7171	8545-0193		-	-		
7172	8545-0196		-	-		
7173	8545-0200		-	-		
-	8545-0206	9285	-	-		
-	8545-0211		-	-		
-	8545-0218		-	-		
-	8545-0225		-	-		
-	8545-0230	9285	-	-		
-	8545-0235		-	-		
-	8542-0145	8568	7703	7717		
-	8542-0150		-	-		
-	8542-0161	8570	-	-		
-	8542-0175		7705	7730		
-	8542-0188		7706	7720		
-	8542-0194		7707	7720		

Page 38

Page 38

Page 39

Page 38

Page 39

Page 42

Page 43



### Applications

- Cleaning Straight Tubes in Fire Tube Boilers, Air Heaters, and Other Pressure Vessels
- 1½ – 4½-Inch (38.1 to 114.3 mm) Outer Diameter Tubes
- Removing Soot and Scale

### Specifications

- 1 HP Drive Unit: 62 lbs. (28kg)
- 2 HP Drive Unit: 72 lbs. (32kg)
- Dimensions: 12" H x 23" W x 11½" D (305 x 584 x 292mm)
- Speed: 1,725 rpm
- Power: 1 HP (WAW-1500-1600)
- 2 HP (WAW-2500-2600)
- Current: 115 Volt 50/60Hz (WAW-1500)
- 220 Volt 50/60Hz (WAW-1600)
- 220 Volt 60Hz (WAW-2500)
- 220 Volt 50Hz (WAW-2600)



Underwriters Laboratories Inc.®  
Specific Models Only



Specific Models Only

### Wils-Away™ Kit Includes:

- Electric Drive Unit with Detachable Dolly and Built-In Tool Box
- Foot Pedal-Single Direction
- 25-Foot (7.6M) Flexible Shaft & Casing
- Vacuum Connector Nozzle
- Set of 6 Steel Spiral Brushes and Adapter  
- or -
- Expanding Steel Brush with Spare Refill Set and Adapter
- Service Manual SM-223

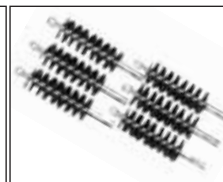

Tube ID Range Inches (mm)	Complete Kit consists of	Drive Unit	- and -	Shaft & Casing	- and -	6 Steel Spiral Brushes	- and -	Shaft Adapter	- or -	Expanding Steel Brush
1.250 - 1.499 (31.8 - 38.1)	WAW-1500	9610	- and -	9730-9025 (9/16 x 12 Male Thread)	- and -	62540-0125	- and -	9893 (1/4 FEM NPT)	- or -	2477-0001
1.500 - 1.749 (38.1 - 44.4)						62540-0150				2477-0006
1.750 - 1.999 (44.5 - 50.8)						62540-0175				2492-0006
2.000 - 2.249 (50.8 - 57.1)						62540-0200				2501-0007
2.250 - 2.499 (57.2 - 63.5)						62540-0225				3441-0005
2.500 - 2.749 (63.5 - 69.8)						62540-0250				3441-0010
2.750 - 2.999 (69.9 - 76.2)						62540-0275				3456-0003
3.000 - 3.249 (76.2 - 82.5)	WAW-2500	9630	- and -	9732-0025 (3/4 x 10 Male Thread)	- and -	62540-0300	- and -	9894 (1/4 FEM NPT)	- or -	3456-0006
3.250 - 3.449 (82.6 - 88.9)						62540-0325				3470-0004
3.500 - 3.749 (88.9 - 95.2)						62540-0350				3470-0007
3.750 - 3.999 (95.3 - 101.6)						62540-0375				3470-0009
4.000 - 4.250 (101.6 - 108.0)						62540-0400				4060-0006

Product Details:

Page 31

Page 27

Page 29



**Smart Tool**

- Each kit includes electric drive unit and all accessories and tools required for thorough tube cleaning.
- Spiral steel brush removes soot in one pass.
- Expanding brush cuts through scale.
- Optional vacuum unit collects soot, keeping work area clean.
- Optional twin foot pedal enables forward/reverse drive.



For **air-powered** tube cleaning, specify the **WAW-4500** Pneumatic Tube Cleaning System. Determine tube Inner Diameter, then select components and accessories from the **WAW-1500-2500** charts. **WAW-4500** uses 1/2-inch Air Hose.

**Accessories**



Expanding Scraper	Drill Head with Universal	Vacuum Connector Nozzle Assembly	Vacuum Cleaners	Vacuum Kits
2606-4151	5185	9877-1500	<b>9487</b> 2 HP Motor with 15-gallon Drum (115V 60Hz)  - or -  <b>9715-1055</b> 4 HP Motor with 55-gallon Drum (115V 60Hz)	<b>9487-1000:</b> General Purpose Vacuum Kit <b>9490-0000:</b> Disposable Vacuum Bags (Pkg of 5) <b>9487-2000:</b> Filter Bag <b>9488-0010:</b> 10-ft Hose
2617-6759	5186	9877-1750		<b>9715-0300:</b> General Purpose Vacuum Kit <b>9715-0100:</b> 15-ft Hose <b>9715-0400:</b> Main Filter <b>9715-0500:</b> Pre Filter
2634-6759	7225	9877-2000		
7985-3070	406-2180	9877-2250		
7987-3070	405-4129	9877-2500		
7989-6261	403-2202	9877-2750		
7991-3077	402-2202	9877-3000		
7992-3079	401-2202	9877-3250		
7993-3079	400-4500	9877-3500		
7994-6930		9877-3750		
7995-6930		9877-4000		
3571-2705		9877-4250		

Page 29

Pages 32-33

Page 18

Page 18



2 HP Vacuum Cleaner



4 HP Vacuum Cleaner



## Vacuum Cleaners and Accessories

**Wilson Vacuum Cleaners** collect the soot that is removed from fire tube boilers when they are cleaned. The **Wilson Vacuum Nozzle** fits over the Shaft & Casing (if you are cleaning with a **Wils-Away™**) or air line and connects to the vacuum unit's hose, so that the soot being removed from the boiler's tubes is drawn into the vacuum cleaner.

Two industrial quality vacuum cleaner motors are available. The 2 HP motor comes with a 15-gallon dolly-mounted drum. The 4 HP motor can be purchased separately or with a 55-gallon dolly-mounted drum. Each vacuum cleaner uses a reusable vacuum bag and disposable filter bags. The 4 HP unit has an additional pre-filter. The Wilson General Purpose Kit includes all required accessories and is a very good value.

### 2 HP Vacuum Cleaner with Dolly



#### Specifications:

Motor HP:	2
Power:	115 Volt 12.9 Amps or 220 Volt 6.5 Amps
Capacity:	15 Gallons
Static Water Lift:	110 Inches
Air Displacement:	114 CFM
Shipping Weight:	65 lbs. (29 Kg)

#### Product Description

Product Description	Part No.
2 HP Vacuum Cleaner (Dry/Wet) with Dolly-Mounted 15-gallon Drum and 10-Foot Hose (115 Volt, 12.9 Amps)	9487-0000
2 HP Vacuum Cleaner (Dry/Wet) with Dolly-Mounted 15-gallon Drum and 10-Foot Hose (220 Volt, 6.5 Amps)	9487-5220
Disposable Vacuum Bags for 2 HP Motor (Package of 5)	9490-0000
Vacuum Filter Bag for 2 HP Motor	9487-2000
Dacron Never-Clog Bag for 2 HP Motor	9487-4000
Water Pick-Up Adapter for 2 HP Motor	9487-0012
Vinyl Vacuum Hose (10 Feet)	9488-0010
Vacuum Nozzle (Refer to Chart on Page 17)	
Service Manual	SM-248

### 4 HP Vacuum Cleaner Head



### 4 HP Vacuum Cleaner with Dolly-Mounted 55-gallon Drum



#### Vacuum Nozzle



#### Specifications:

Motor HP:	4
Power:	115 Volt 21 Amps or 220 Volt 10.5 Amps
Capacity:	55 Gallons
Static Water Lift:	110 Inches
Air Displacement:	220 CFM
Shipping Weight:	45 lbs. (20 Kg) 140 lbs. (64 Kg) with 55-gallon Drum and Dolly

#### Product Description

Product Description	Part No.
4 HP Vacuum Cleaner Head – Dry only (115 Volt, 21 Amps)	9715-0055
4 HP Vacuum Cleaner Head – Dry only (220 Volt, 10.5 Amps)	9716-0055
4 HP Vacuum Cleaner with 55-gallon Drum – Dry only (115 Volt, 21 Amps)	9715-1055
4 HP Vacuum Cleaner with 55-gallon Drum – Dry only (220 Volt, 10.5 Amps)	9716-1055
4 HP Main Filter	9715-0400
4 HP Pre Filter	9715-0500
Vinyl Vacuum Hose (15 Feet)	9715-0100
Vacuum Nozzle (Refer to Chart on Page 17)	
Service Manual	SM-247

#### Accessories for 2 HP and 4 HP Vacuums:

Vacuum Tool Kit – Dry application (Wand, Crevice Tool, Scraper Tool, and Blower Nozzle Floor Tool, 11-Inch Plastic Crevice Tool and 11-Inch Aluminum Crevice Tool)	9487-1000
Vacuum Tool Kit – Dry/Wet Application (Wand, 14-Inch Plastic Floor Tool, 18-Inch Aluminum Floor Tool, 11-Inch Plastic Crevice Tool, and 11-Inch Aluminum Crevice Tool)	9715-0300



Tool Kit  
Dry Application



Tool Kit  
Dry/Wet Application



4 HP Main Filter



10-Foot Vinyl Hose



2 HP Disposable Bags

# FT Series Air-Driven Tube Cleaning System



### Applications

- Cleaning Pipes or Straight Tubes in Fire Tube Boilers and Other Pressure Vessels
- 2 – 4½-Inch (50.8 to 114.3mm) Outer Diameter Tubes
- Removing Powdery and Gummy to Soft Scale

### Specifications

- Speed: Up to 6,000 rpm
- Air: 80 to 125 CFM
- Motor: Positive starting, non-stalling, six-blade rotor and double-chambered power seal cylinder

### Smart Tool

- Each kit includes air motor and all accessories required for thorough tube cleaning.
- Powerful air motor speeds cleaning.
- One man operation improves productivity.
- Expanding brush removes dry and scaly residue.
- Expanding scraper cuts through soft or gummy deposits.
- Optional Model CHJ Cutter Head cleans out heavy deposits.

### FT Series Kit Includes:

- EP Air Motor
- Type C Flexible Holder
- Expanding Steel Brush and Spare Refill Set
- or -
- Expanding Scraper and Spare Set of Scrapers
- Set of Spare Rotor Blades and Rotor Wrench
- Tool Box
- Service Manual SM-163 (FT-175) SM-159 (FT-212 to 362)



Tube ID Range Inches (mm)	Complete Kit	consists of	Air Motor	and	Expanding Steel Brush	or	Expanding Scraper	Motor Diam.		CFM
								Inches	(mm)	
1.750 - 2.124 (44.5-53.9)	FT-175		2000-0156		2492-0006		2635	1 1/8	(39.7)	47
2.125 - 2.624 (54.0-66.6)	FT-212		2012-0200		3442-0001		7986-2416	2	(50.8)	70
2.625 - 3.124 (66.7-79.3)	FT-262		7968-0256		3456-0001		7990-2354	2 3/8	(65.1)	73
3.125 - 3.624 (79.4-92.0)	FT-312		2058-0300		3471-0002		7992-3080	3	(76.2)	108
3.625 - 4.125 (92.1-104.8)	FT-362		2058-0350		3471-0007		7994-3081	3 1/2	(88.9)	

Product Details:

Page 44

Page 29

Page 29

## Accessories



FT Kit	CHJ Series Cutter Head	Drill Head with Universal	Armored Air Hose Part No.	Inches	Air Valve	Air Line Lubricator	Kit Weight (Less Options)
							Pounds (Kg)
FT-175	4261-3996	7225	8974-0025	1/2	8654	53360	5 1/2 (2.5)
FT-212	4344-4382	406-2209	8975-0025	3/4	8647	53361	9 3/8 (4.3)
FT-262	3209-6518	405-4952					10 1/2 (4.6)
FT-312	3215-6919	402-2208					17 1/2 (7.9)
FT-362	3219-6919	401-2208	8976-0025	1	8669	53363	19 1/2 (8.8)

Product Details:

Page 36

Pages 32/33

Page 42

Page 43

Page 43





### Applications

- Cleaning Curved or Straight Tubes or Pipes in Water Tube Boilers, Other Pressure Vessels, Transmission Lines, and Many Other Applications
- 1 – 2½-Inch (25.4 to 63.5mm) Outer Diameter Tubes
- Removing Light to Medium Soft Deposits

### Specifications

- Speed: 9,000 rpm
- Air: 80 to 125 psi
- Motor: Steel rotor blades and precision ground surfaces result in high-performance and durability

### C Series Kit Includes:

- C Air Motor
- Type C Flexible Holder
- Expanding Steel Brush and Spare Refill Set - and -
- Model A Cutter Head and Spare Set of Cutters
- 25-Foot Air Hose with Coupling
- Set of Spare Rotor Blades and Rotor Wrench
- Tool Box
- Service Manual SM-8B

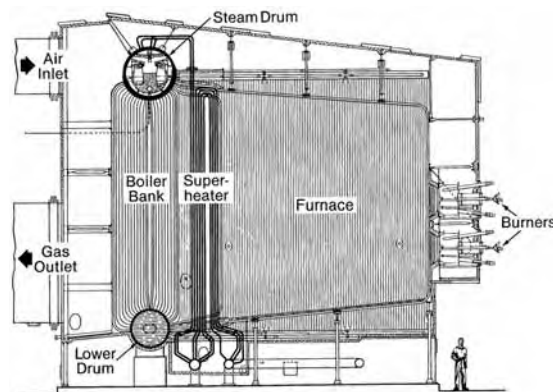

Industrial Water Tube Boiler



Tube ID Range Inches	(mm)	Kit	Air Motor consists of	Flexible Holder	Expanding Steel Brush	Model A Cutter	Air Hose Part No.	Inches	Motor Diam.		CFM
									Inches	(mm)	
.781 - .874	(19.8 - 22.2)	C-2	2745	2265	2456-0002	7213	7040-0025	1/4	11/16	(17.5)	12
.875 - .999	(22.2 - 25.4)	C-3	2755	2271	2456-0004	7218	7040-9025	1/4	49/64	(19.4)	13
1.000 - 1.124	(25.4 - 28.5)	C-4	2763	2279	2463-0003	7219	8971-0025	3/8	7/8	(22.2)	18
1.125 - 1.217	(28.6 - 30.9)	C-5	2773		2463-0007	7220			31/32	(24.6)	25
1.218 - 1.499	(31.0 - 38.1)	C-6	2783	2285	2470-0001	7221			1½	(27.8)	30
1.500 - 1.749	(38.1 - 44.4)	C-8	2793	2296	2477-0005	7222	8972-0025	3/8	1¼	(32.1)	35
1.750 - 1.999	(44.5 - 50.8)	C-8A*		-	2678-0004	7223	Armored		1½	(34.1)	40
2.000 - 2.250	(50.8 - 57.2)	C-10	2799	2296	2484-0006	7224	8974-0025	1/2	1¾	(40.5)	50
		C-12	8588	2862	2493-0006		Armored				

Product Details:

Page 46

Page 33

Page 28

Page 32

Page 42

\* Package Boiler Kit





**Smart Tool**

- Complete kit includes air motor, all required accessories, spare parts, air hose and tools required for a thorough tube cleaning job.
- Air motor has power needed to remove scale.
- One man operation improves productivity.
- Expanding brush removes light deposits without damaging tube wall.
- Cutter head cuts through heavier deposits and hard scale
- Soft, dusty deposits: expanding brush.
- Gummy deposits: expanding scraper.
- Hard, cement-like scale: Model A Cutter Head.



Although the C-Series Kits are recommended, please see page 11 for a Wils-Away™ Pneumatic alternative.

**Accessories**

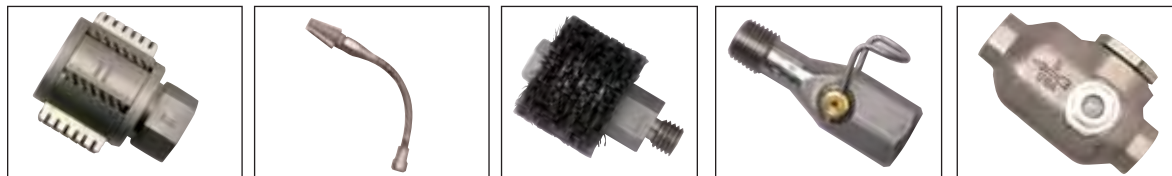

Expanding Scraper	Model B Cutter Head	Sectional Steel Brush	Air Valve	Air Line Lubricator	Kit Weight (less options)	
					Pounds	(Kg)
2578	8063	8353-0068	-	52035	4½	(2.2)
2586	8072	8353-0075	-		5	(2.3)
2592	8066	8353-0081	9439		6	(2.7)
2600	8073	8354-0100	-	52399	8½	(3.7)
2506	8074	8354-0106	8774		11½	(5.1)
2617	8069	8356-0131			11½	(5.3)
-	-	-			12	(5.4)
2634	8070	8357-0156	12½		(5.8)	
2043	8075	8358-0175	8654	53360	17½	(7.8)

Page 28

Page 32

Page 40

Page 43

Page 43

# Water Tube Boilers

## ECT Series Air-Driven Tube Cleaning System



### Applications

- Cleaning Curved or Straight Tubes in Boilers, Superheaters, Economizers, and Other Large Diameter Pressure Vessels
- 2½ - 7½-Inch (63.5 to 190.5mm) Outer Diameter Tubes
- Removing Medium to Heavy Hard Deposits

### Specifications

- Speed: 10,000 rpm
- Air: 80 to 125 psi
- Motor: Phenolite® rotor blades and precision ground surfaces result in high-performance and durability

### Smart Tool

- Powerful air motor and extra duty cleaning heads remove even the heaviest deposits.
- CHJ Cutter Head removes medium hard deposits in one pass.
- SE Cutter Head cuts through heavier deposits.
- Use expanding brush or expanding scraper for light duty cleaning applications.

### ECT Series Kit Includes:

- Series ECT Air Motor with Set of Spare Rotor Blades
- Model CHJ or SE Cutter Head with Spare Set of Cutters, Cutter Pins, and Hinge Pins
- Tool Box and Set of Wrenches
- Service Manual SM-150

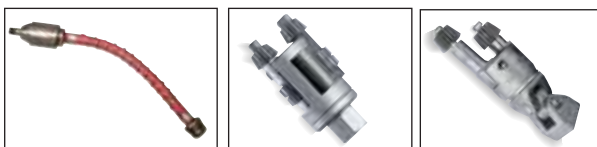

Tube ID Range Inches	Tube ID Range (mm)	Complete Kit	includes	Air Motor	- and -	Model CHJ Cutter Head	- or -	Model SE Cutter Head	Motor Diam. Inches	Motor Diam. (mm)	CFM
2.125 - 2.374	(54.0 - 60.3)	ECT-212		4090-0175		4195-4606		4599-4606	1¾	(44.5)	35
2.375 - 2.624	(60.3 - 66.6)	ECT-237		4090-0200		3203-4650		4595-4650	2	(50.8)	
2.625 - 2.874	(66.7 - 73.0)	ECT-262		4925-0225		3203-4596		4595-4596	2¼	(57.2)	55
2.875 - 3.124	(73.0 - 79.3)	ECT-287		4099-0256		3230-4596		4632-4596	2⅝	(65.1)	65
3.125 - 3.624	(79.4 - 92.0)	ECT-312		4035-0275		3230-9308		4640-4644	2⅞	(69.9)	85
3.625 - 3.999	(92.1 - 101.6)	ECT-362		4035-0318		3237-4644			3⅞	(81.0)	
4.000 - 4.499	(101.6 - 114.3)	ECT-400		4541-0325		3237-9966		3971-2631	3¼	(82.6)	110
4.500 - 4.999	(114.3 - 127.0)	ECT-450		4541-0375		3226-6558		4117-2631	3⅝	(95.3)	
5.000 - 5.499	(127.0 - 139.7)	ECT-500		4315-0425			2174-7274		4121-3153	4¼	(108.0)
5.500 - 5.999	(139.7 - 152.4)	ECT-550		4315-0450		4121-3153				4½	(114.3)
6.000 - 6.499	(152.4 - 165.1)	ECT-600		4315-0500			4121-3153		-	5	(127.0)
6.500 - 7.000	(165.1 - 177.8)	ECT-650		4315-0550		-				5½	(139.7)

Product Details:

Page 46

Page 36

Page 34

### Accessories



ECT Kit	Expanding Steel Brush	Expanding Scraper	Sectional Steel Brush	Drill Head with Universal	Air Hose Part No. Inches	Air Valve	Air Line Lubricator	Kit Weight (Less Options) Pounds (Kg)
ECT-212	3442-0001	7985-2416	8359-0200 <sup>1</sup>	407-2180	8974-0025 1/2	8654	53360	6½ (2.9)
ECT-237	3442-0005	7987-2416	8360-0225 <sup>1</sup>	406-2209				8 (3.6)
ECT-262	3444-0010	7989-2354	8361-0250 <sup>2</sup>	405-4952	8975-0025 3/4	8647	53361	9 (4.1)
ECT-287	3456-0003	7991-3077						16 (7.3)
ECT-312	3471-0002	7992-3080		403-2208	8976-0025 1	8669	53363	19 (8.6)
ECT-362	3471-0007	7994-3081		402-2208				19½ (8.9)
ECT-400	4060-0007	3571-4021		401-2196	8976-0025 1	8669	53363	19¾ (9.0)
ECT-450	3497-0437	3576-4021						20¾ (9.4)
ECT-500	3500-0500	3578-3513		400-2631	8976-0025 1	8669	53363	26¼ (11.9)
ECT-550			31 (14.1)					
ECT-600								32 (14.5)
ECT-650								35¼ (16.0)

Page 29

Page 29

Page 40

Pages 32/33

Page 42

Page 43

Page 43

1. Requires Universal Joint (Part No. 2209). 2. Requires Universal Joint (Part No. 4952).



**Wils-Away™ Electric Plant Manager's Kit**



For accessories or optional cleaning heads, refer to Page 7 for Heat Exchanger products or Page 17 for Boiler products.

**Applications**

- Cleaning **BOTH** Boilers and Heat Exchangers
- 3/8 – 4½-Inch (9.5 to 114.3mm) Outer Diameter Tubes
- Removing Soot and Scale from Boiler, Light to Medium Soft Deposits from Heat Exchanger

**Specifications**

1 HP Drive Unit: 62 lbs. (28Kg)  
 Dimensions: 12" H x 23" W x 11½" D (305 x 582 x 292mm)  
 Speed: 1,725 rpm  
 Power: 1 HP (WAW-1500/1600)  
 Current: 115 Volt 50/60Hz (WAW-1500)  
 115 Volt 50Hz (WAW-1600)

**Plant Manager's Kit Includes:**

- Electric Drive Unit with Detachable Dolly and Built-In Tool Box
- Foot Pedal-Single Direction
- 25-Foot Flexible Shaft & Casing (for cleaning Heat Exchanger)
- 25-Foot Flexible Shaft & Casing (for cleaning Boiler)
- 6 Nylon Spiral Brushes or Expanding Brush (for cleaning Heat Exchanger)
- Expanding Brush with Refill Set (for cleaning Boiler)
- 2 HP Vacuum Cleaner
- Vacuum Connector Nozzle
- Service Manual SM-223

Determine Inner Diameter of heat exchanger and Inner Diameter of boiler, then select two Shaft & Casings, one for heat exchanger and one for boiler. Select either set of 6 spiral brushes or expanding brush to clean heat exchanger, and select expanding brush to clean boiler.

	Tube ID Range		Complete Kit	Drive Unit	Shaft & Casing	6 Nylon Spiral Brushes	Expanding Brush*	Brush Adapter	Vacuum Nozzle†		
	Inches	(mm)									
▲ - Heat Exchanger Tube ID -	.281 - .311	(7.1 - 7.9)	WAW-9000	9610 (115V 50/60Hz) - or - 9610-2200 (220V 50Hz)	9720-0015 (8x32 Female Thread)	61746-4025	9900-3003	9589 (5/16x18 Female Thread)			
	.312 - .342	(7.9 - 8.7)				61746-4028					
	.343 - .374	(8.7 - 9.5)				61746-4031					
	.375 - .405	(9.5 - 10.3)				61746-4034					
	.406 - .436	(10.3 - 11.1)				62501-4037					
	.437 - .499	(11.1 - 12.7)				9722-0025 (1/4x28 Female Thread)				62501-4043	
	.500 - .561	(12.7 - 14.2)			62501-4050	62501-4056	9900-3006				
	.562 - .624	(14.2 - 15.8)			62501-4062	62501-4068	2456-3002				
	.625 - .686	(15.8 - 17.4)			9724-0025 (1/4x28 Female Thread)	62501-4075	2456-3003				
	.687 - .749	(17.4 - 19.0)			62501-4081	2456-3004	2456-3006				
	.750 - .811	(19.0 - 20.6)			62501-4087	2456-3006	2463-3004				
	.812 - .874	(20.6 - 22.2)			62501-4093	2463-3005	2463-3007				
	.875 - .936	(22.2 - 23.8)			-	2463-3008	2470-3002				
	.937 - .999	(23.8 - 25.4)			-						
1.000 - 1.061	(25.4 - 26.9)										
1.062 - 1.124	(26.9 - 28.5)										
1.125 - 1.186	(28.5 - 30.1)										
1.187 - 1.249	(30.1 - 31.7)										
▲ - Boiler Tube ID -	1.250 - 1.499	(31.8 - 38.1)	WAW-9100	9630 (220V 60Hz) 9630-2250 (220V 50Hz)	9730-9025 (9/16x12 Male Thread)	2477-0001	6759 (7/16x14 Female Thread)	9877-1500	9877-1750		
	1.500 - 1.749	(38.1 - 44.4)				2477-0006					
	1.750 - 1.999	(44.5 - 50.8)				2492-0006					
	2.000 - 2.249	(50.8 - 57.1)				2501-0007					
	2.250 - 2.499	(57.2 - 63.5)				3441-0005					
	2.500 - 2.749	(63.5 - 69.8)				3441-0010					
	2.750 - 2.999	(69.9 - 76.2)				3456-0003					
	3.000 - 3.249	(76.2 - 82.5)				3456-0006					
	3.250 - 3.349	(82.6 - 88.9)				3470-0004					
	3.350 - 3.749	(88.9 - 95.2)				3470-0007					
	3.750 - 3.999	(95.3 - 101.6)				3470-0009					
	4.000 - 4.250	(101.6 - 108.0)				4060-0060				2705 (7/8x9 Male Thread)	9877-2000
											9877-2250
											9877-2500
				9877-2750							
				9877-3000							
				9877-3250							
				9877-3500							
				9877-3750							
				9877-4000							
				9877-4250							

Product Details:

Pages 16/17

Page 31

Page 27

Pages 28/29

Page 41

Page 17

\* Bronze Expanding Brush up to 1.249 Tube Inner Diameter; Steel Expanding Brush for 1.250 Tube Inner Diameter and larger.

† Requires Connector (Part No. 9875).



## EP Series Air-Driven Tube Cleaning System



### Applications

- Cleaning Straight Tubes in Boilers and Large Diameter Pressure Vessels
- 1½ – 6½-Inch (38.1 to 165.1mm) Outer Diameter Tubes
- Removing Medium to Heavy Deposits

### Specifications

Speed: up to 9,000 rpm

Air: 80 to 125 psi

Motor: Double-chambered power seal cylinder and light blade design produce high torque and ensure long motor life

### EP Series Kit Includes:

- EP Air Motor
- Model A or Model R Cutter Head
- or -
- Drill Head
- Set of Spare Rotor Blades and Rotor Wrench
- Tool Box
- Service Manual SM-163



Tube ID Range		Complete Kit	includes	Air Motor	- and -	Model A or R Cutter Head	- or -	Drill Head	Motor Diam.		CFM
Inches	(mm)								Inches	(mm)	
1.375 - 1.449	(34.9 - 38.1)	EP-137		4622-0131		5788		409-2212	1⅞	(33.3)	32
1.500 - 1.749	(38.1 - 44.4)	EP-150		3942-0143		5183			1⅞	(36.5)	45
1.750 - 1.999	(44.5 - 50.8)	EP-175		2000-0156		7494-2411		408-2140	1⅞	(39.7)	47
2.000 - 2.249	(50.8 - 57.1)	EP-200		2012-0181		7509-2416		407-2180	1⅞	(46.0)	70
2.250 - 2.499	(57.2 - 63.5)	EP-225		7968-0212		9311-2354		406-4555	2⅞	(54.0)	73
2.500 - 2.749	(63.5 - 69.8)	EP-250		2044-0231		7329-2354		405-4952	2⅞	(58.7)	100
2.750 - 2.999	(69.9 - 76.2)	EP-275		2058-0262		7334-2360		405-2202	2⅞	(66.7)	108
3.000 - 3.249	(76.2 - 82.5)	EP-300		2072-0281		7512-2366		403-4950	2⅞	(71.4)	152
3.250 - 3.499	(82.6 - 88.9)	EP-325		2072-0306		7479-2366			3⅞	(77.8)	
3.500 - 3.749	(88.9 - 95.2)	EP-350		2091-0325		7339-2376		402-2196	3¼	(82.6)	164
3.750 - 3.999	(95.3 - 101.6)	EP-375		2091-0350		7474-2376			3½	(88.9)	
4.000 - 4.249	(101.6 - 107.9)	EP-400		2109-0375		7344-2376		401-2196	3¾	(95.3)	175
4.250 - 4.499	(108.0 - 114.3)	EP-425		2109-0400							
4.500 - 4.749	(114.3 - 120.6)	EP-450		2109-0425		7349-2376		400-2631	4¼	(108.0)	175
4.750 - 4.999	(120.7 - 127.0)	EP-475		2109-0450							
5.000 - 5.249	(127.0 - 133.3)	EP-500		2109-0475		7482-2376		400-2631	4¾	(114.3)	175
5.250 - 5.499	(133.4 - 139.7)	EP-525		3142-0500							
5.500 - 5.749	(139.7 - 146.0)	EP-550		3142-0525		7485-3085		400-3153	5	(127.0)	225
5.750 - 5.999	(146.1 - 152.4)	EP-575		3142-0550							
6.000 - 6.250	(152.4 - 158.8)	EP-600		3142-0575					5¼	(133.4)	225
									5½	(139.7)	
									5¾	(146.1)	

Product Details:

Page 44

Pages 32/35

Pages 32/33



**Smart Tool**

- Each kit includes air motor and all accessories and tools required for thorough tube cleaning.
- Powerful air motor speeds cleaning.
- One man operation improves productivity.
- Model A or R Cutter Head removes medium deposits.
- Drill Head cuts through heavier deposits.



**Accessories**



Expanding Steel Brush	Expanding Scraper	Swing Frame Steel Brush	Armored Air Hose Part No.	Inches	Air Valve	Air Line Lubricator	Kit Weight (Less Options)	
							Pounds	(Kg)
2477-9004	2625	4824-9031	8972-0025	3/8	8774	52399	3½	(1.7)
2477-9006	2617						4¾	(2.0)
2492-0006	2634						5½	(2.7)
2494-0007	7985-2416						7¾	(3.6)
3444-0003	7987-4130						11¼	(5.1)
3444-0010	7989-2354						13	(5.9)
3457-0003	7991-2360						18	(8.2)
3471-0002	7992-2366						21½	(9.6)
3471-9004	7993-2366						24¾	(11.2)
3471-9007	7994-2376						32½	(14.7)
4060-9003	7995-2376						35¾	(16.2)
4060-0007	3571-4021						36¾	(16.4)
3497-9437	3574-4021						37¾	(17.1)
3497-9500	3576-4021	41¼	(18.7)					
3500-9437	3578-3513	43¾	(19.7)					
3500-8437	3578-3584	47¾	(21.5)					
61312-0000		61427-9040	68¾	(31.0)				
3504-0437	3581-3585	69¾	(31.5)					
		61427-9050	72¾	(32.7)				
		4834-9040	75¾	(34.2)				
8975-0025	3/4	8647	8976-0025	1	8669	53363	37¾	(17.1)
8976-0025	1	8669					41¼	(18.7)
8976-0025	1	8669					43¾	(19.7)
8976-0025	1	8669					47¾	(21.5)
8976-0025	1	8669					68¾	(31.0)
8976-0025	1	8669					69¾	(31.5)
8976-0025	1	8669					72¾	(32.7)
8976-0025	1	8669					75¾	(34.2)

Pages 28-29

Pages 28-29

Page 37

Page 42

Page 43

Page 43

	<p><b>Spiral Brushes</b> <i>P. 27</i> 1/4 to 4-Inch ID Tubes in Heat Exchangers, Condensers, Chillers, Absorbers, Fire Tube, and Water Tube Boilers</p>	<p><b>Removes Light to Medium Debris</b> Available in nylon, brass, steel, and stainless steel. Always match metals, using bronze for nonferrous tubes and steel for ferrous metals. Nylon brushes can be used with all tubes and will not damage the interior tube wall!</p>	<p><b>Wils-Away™</b> Electric and Pneumatic Tube Cleaning Systems</p>
	<p><b>Specialty Brushes</b> <i>P. 27</i> 1/2 to 1-Inch ID Tubes in Surface Condensers and Enhanced Tubes in Heat Exchangers</p>	<p><b>Cleans Enhanced and Surface Condenser Tubes</b> <b>Wilson Spin Grit Brushes</b> feature silicone carbide-impregnated long bristles that lay over to clean prime surfaces in condenser tubes. <b>Wilson Spin Clean Brushes</b> use tapered trim, abrasive-impregnated brushes to clean enhanced tubes in heat exchangers.</p>	<p><b>ALL Wilson</b> Electric and Pneumatic Tube Cleaning Systems</p>
	<p><b>Expanding Brushes</b> <i>P. 28-29</i> 1/2 to 6-Inch ID Tubes in Heat Exchangers, Condensers, Chillers, Absorbers, Fire Tube, and Water Tube Boilers</p>	<p><b>Removes Soft to Powdery Deposits</b> The BEST value in tube cleaning, the <b>Wilson Expanding Brush</b> lasts at least 10 times longer than fixed diameter brushes, and refills keep the <b>expanding brush</b> both durable and economical. Available with nylon, bronze, steel, or stainless steel bristles.</p>	<p><b>ALL Wilson</b> Electric and Pneumatic Tube Cleaning Systems</p>
	<p><b>Expanding Scrapers</b> <i>P. 28-29</i> 1/2 to 6-Inch ID Tubes in Heat Exchangers, Condensers, Chillers, Absorbers, Fire Tube, and Water Tube Boilers</p>	<p><b>Removes Wet and Gummy Deposits</b> Centrifugal force lifts scraper blades, forcing them against tube interior and adjusting automatically for changes in tube ID. Scraper refills prolong the life of this cleaning head and keep it very economical.</p>	<p><b>ALL Wilson</b> Electric and Pneumatic Tube Cleaning Systems</p>
	<p><b>Buffing Tools</b> <i>P. 27</i> 3/8 to 3-Inch ID Tubes in Heat Exchangers, Condensers, Chillers, Absorbers, Fire Tube, and Water Tube Boilers</p>	<p><b>Removes Light to Medium Scale</b> The <b>Wilson Buffing Tool</b> is available with a unique drill tip that cuts through heavier deposits. Also use the <b>buffing tool</b> to finish tubes after initial cleaning by <b>Wilson Cutter Heads, Drill Heads, or Cutter Bits</b>.</p>	<p><b>ALL Wilson</b> Tube Cleaning Systems (and competing drive units)</p>
	<p><b>Small Cutter Heads</b> <i>P. 32</i> 1/2 to 2-Inch ID Straight or Curved Tubes in Heat Exchangers, Condensers, Chillers, and Water Tube Boilers</p>	<p><b>Removes Thin to Medium Soft or Hard Scale</b> <b>Model A Cutter Head</b> attaches directly to motor. <b>Model B Cutter Head</b> attaches to <b>Type C Flexible Holder</b> for curved tube cleaning. All <b>cutter heads</b> feature non-tracking design for more effective cleaning.</p>	<p><b>ALL Wilson</b> Tube Cleaning Systems</p>
	<p><b>Large Cutter Heads</b> <i>P. 34-37</i> 1 1/2 to 22-Inch ID Tubes in Boilers, Power Plants, Refineries, and Other Industrial Applications</p>	<p><b>Removes Heavy, Hard Deposits</b> <b>Model SE:</b> Straight or curved tubes to 6-inch ID. <b>Model R:</b> Straight tubes to 11 1/2-inch ID. <b>Model CHJ:</b> Straight or curved tubes to 22-inch ID. <b>Swing Frame Brush:</b> Straight pipes to 20 1/2-inch ID.</p>	<p><b>Wilson</b> Air Motors</p>
	<p><b>Drill Heads</b> <i>P. 33</i> 2 to 6-Inch ID Tubes in Fire Tube and Water Tube Boilers, and Other Large Diameter Pressure Vessels</p>	<p><b>Cleans Totally Clogged Tubes/Hard Scale</b> Literally drills through clogged tubes and heaviest scale and coke. Can be used to clean curved tubes by mounting the <b>drill head</b> on a <b>universal joint</b> or <b>flexible holder</b>.</p>	<p><b>ALL Wilson</b> Tube Cleaning Systems</p>
	<p><b>Cutter Bits</b> <i>P. 38</i> 3/8 to 2 3/8-Inch ID Tubes in Heat Exchangers, Condensers, Chillers, Refineries, Pulp and Paper Plants, and Other Industrial Applications</p>	<p><b>Cuts Through Hard Scale/Plugged Tubes</b> <b>M Bit:</b> Affordable, general purpose removal of hard scale. <b>SPE-DUR Bit:</b> Excellent for plugged tubes. <b>K Bit:</b> Features carbide tip that will break through hardest scale and deposits.</p>	<p><b>PG/PGX-2/TP-302</b> and other <b>Wilson</b> Tube Cleaning Systems</p>
	<p><b>P Brushes</b> <i>P. 38</i> 3/8 to 2 3/8-Inch ID Tubes in Heat Exchangers, Condensers, Chillers, Evaporators, and Other Industrial Pressure Vessels</p>	<p><b>Post Cutter Bit Finishing/Push Rod Cleaning</b> <b>P Brush</b> is used for finishing up after a <b>cutter bit</b> has been used to remove hard or heavy scale or deposit. The <b>P Brush</b> is also used with push rod for manual cleaning of condensers, evaporators, and fire tube boilers.</p>	<p><b>PG/PGX-2/TP-302</b> and other <b>Wilson</b> Tube Cleaning Systems</p>



# Spiral Brushes



**Wilson Spiral Brushes** are economical, and they are easy to install and use. They are available in nylon, brass (for copper tubes), steel, and stainless steel. Always match metals, using a steel brush to clean steel tubes, for example. Use stainless steel spiral brushes to clean titanium and copper nickel tubes. Nylon brushes can be used with all tube materials.

Water travels through the flexible Shaft and Casing, providing a flushing action to aid the cleaning process. When the water running out of the tube is clear, the tube is clean.

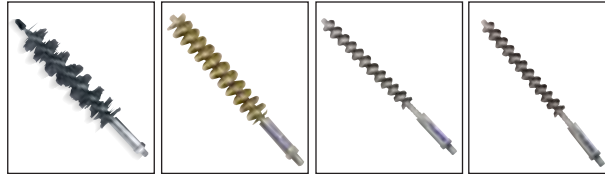

All brushes are available individually or in pkg. of 15 or 25 (depending on brush)

Tube ID Range		Brush Diameter		Nylon Spiral Brush*	Brass Spiral Brush*	Stainless Steel Spiral Brush*	Steel Spiral Brush*	Thread Male (M)
Inches	(mm)	Inches	(mm)					
.281 - .311	(7.1 - 7.9)	1/4	(6.4)	61746-4025	61746-3025	61746-2025	-	8x32 (M)
.312 - .342	(7.9 - 8.7)	9/32	(7.1)	61746-4028	61746-3028	61746-2028	-	
.343 - .374	(8.7 - 9.5)	5/16	(7.9)	61746-4031	61746-3031	61746-2031	-	
.375 - .405	(9.5 - 10.3)	11/32	(8.7)	61746-4034	61746-3034	61746-2034	-	
.406 - .436	(10.3 - 11.1)	3/8	(9.5)	62501-4037	62501-3037	62501-2037	62501-0037	1/4x28 (M)
.437 - .499	(11.1 - 12.7)	7/16	(11.1)	62501-4043	62501-3043	62501-2043	62501-0043	
.500 - .561	(12.7 - 14.2)	1/2	(12.7)	62501-4050	62501-3050	62501-2050	62501-0050	
.562 - .624	(14.2 - 15.8)	9/16	(14.3)	62501-4056	62501-3056	62501-2056	62501-0056	
.625 - .686	(15.8 - 17.4)	5/8	(15.9)	62501-4062	62501-3062	62501-2062	62501-0062	
.687 - .749	(17.4 - 19.0)	11/16	(17.5)	62501-4068	62501-3068	62501-2068	62501-0068	
.750 - .811	(19.0 - 20.6)	3/4	(19.1)	62501-4075	62501-3075	62501-2075	62501-0075	
.812 - .874	(20.6 - 22.2)	13/16	(20.6)	62501-4081	62501-3081	62501-2081	62501-0081	
.875 - .936	(22.2 - 23.8)	7/8	(22.2)	62501-4087	62501-3087	62501-2087	62501-0087	
.937 - .999	(23.8 - 25.4)	15/16	(23.8)	62501-4093	62501-3093	62501-2093	62501-0093	
1.000 - 1.061	(25.4 - 26.9)	1	(25.4)	62501-4100	62501-3100	62501-2100	62501-0100	

## Spin Grit Brushes for Smooth Bore Tubes

Abrasive brush with silicone carbide impregnated nylon recommended for brass tubes. This brush is made oversized, so the filament will lay over, resulting in increased contact with surface, providing better cleaning and longer life than conventional condenser cleaning brushes.



Tube ID Range		Spin Grit Brushes	Brush Diameter	Thread Male (M)
Inches	(mm)			
.250 - .375	(6.3 - 9.5)	62551-0050	.500	1/4-28(M)
.375 - .500	(9.5 - 12.7)	62551-0062	.625	
.500 - .625	(12.7 - 15.9)	62551-0075	.750	
.625 - .812	(15.9 - 20.6)	62551-0100	1.000	
.812 - 1.000	(20.6-25.4)	62551-0125	1.125	

## Spin Clean Brushes for Internally Enhanced Tubes

This abrasive brush is made with a tapered trim to allow cleaning of enhanced condenser tubes. The long bristles are designed oversized with the intention of being bent over, allowing the aggressive filament to come into maximum contact with the lands. The short bristles are able to get into the grooves.



Tube ID Range		Spin Clean Brushes	Small Diameter	Large Diameter	Thread Male (M)
Inches	(mm)				
.500	(12.7)	62615-0075	.500	.750	1/4-28(M)
.625	(15.9)	62615-0100	.625	1.000	
.750	(19.0)	62615-0112	.750	1.125	
1.000	(25.4)	62615-0175	1.000	1.375	

## Buffing Tools

### Applications

- Finish-Up Cleaning of 1/2 – 3 1/2-Inch (12.7 - 88.9mm) Outer Diameter Tubes
- Set of Wires Clean Away Debris after Using Expanding Brush or Expanding Scraper
- Replacement Wire Blades Keep Unit Affordable

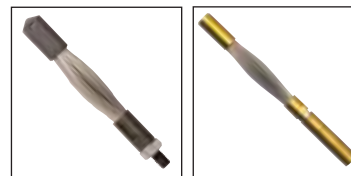

Tube ID Range		Buffing Tool with Tip	Buffing Tool without Tip	Replacement Blades	Drive Thread
Inches	(mm)			(#)	
.312-.375	(7.9-9.5)	62622-0005	62624-0005	62623-0006 (18)	8 x 32 (M)
.375-.500	(9.5-12.7)	62622-0006	62624-0006		
.500-.625	(12.7-15.9)	62622-0007	62624-0008	62623-0008 (18)	1/4 x 28 (M)
.625-1.000	(15.9-25.4)	62622-0010	62624-0010	62623-0010 (18)	7/16 x 14 (M)
1.000-3.000	(25.4-76.2)	62626-0000	62625-0000	62625-0001 (20)	

## Expanding Brush and Expanding Scraper



The **Wilson Expanding Brush** is a Thomas C. Wilson, Inc. exclusive! This unique cleaning head is ideal for removing light to medium powdery deposits such as rust, scale, and chemical precipitates in tubes from 5/8-inch – 6½-inch (15.9 to 165.1mm) Outer Diameter. And the **Wilson Expanding Brush** is an excellent value because it lasts **10 to 20 times longer than conventional brushes!**

As the head spins, the brush cartridges rise and automatically conform to the inside of the tube. **Wilson Expanding Brushes** outlast conventional fixed-diameter brushes by a factor of at least 10, because as the bristles wear, the brushes simply rise farther, so they continue to conform to the inside of the tube!

The **Wilson Expanding Brush** is available with steel, stainless steel, bronze, or nylon brush bristles. The metal in the **expanding brush** should always match the tube material. Bronze brushes should be used with copper and brass tubes, and stainless steel should be used with titanium and copper nickel tubes. Nylon brushes can be used with all metals.

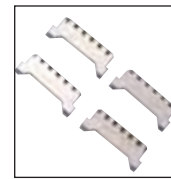
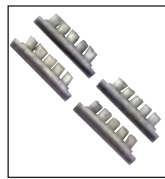
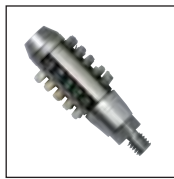

Tube ID Range Inches (mm)	Expanding Brush* Assembly	Cleaning Range Inches	Brush Refill Set* Part No.	Expanding Scraper Assembly	Cleaning Ranges Inches	Scraper Refill Set Part No. (#)	Thread Male (M) or Female (F)
.482 - .495 (12.2 - 12.6)	7000-0001	.453 - .487	7003-0001 (4)	2569	.437 - .625	2574 (4)	12 x 28 (M)
.496 - .527 (12.6 - 13.4)	7000-0002	.485 - .519	7003-0002 (4)				
.528 - .555 (13.4 - 14.1)	7000-0003	.518 - .552	7003-0003 (4)				
.556 - .584 (14.1 - 14.8)	7000-0004	.542 - .576	7003-0004 (4)				
.585 - .620 (14.8 - 15.7)	7000-0005	.578 - .612	7003-0005 (4)				
.621 - .652 (15.7 - 16.6)	7000-0006	.610 - .644	7003-0006 (4)				
.653 - .680 (16.6 - 17.3)	7000-0007	.638 - .672	7003-0007 (4)				
.528 - .555 (13.4 - 14.1)	9900-0003	.518 - .552	7003-0003 (4)	2549	.500-.687	2577 (4)	1/4 x 28 (M)
.556 - .584 (14.1 - 14.8)	9900-0004	.542 - .576	7003-0004 (4)				
.585 - .620 (14.8 - 15.7)	9900-0005	.578 - .612	7003-0005 (4)				
.621 - .652 (15.7 - 16.6)	9900-0006	.610 - .644	7003-0006 (4)				
.653 - .680 (16.6 - 17.3)	9900-0007	.638 - .672	7003-0007 (4)				
.681 - .709 (17.3 - 18.0)	2456-0001	.611 - .752	2457-0001 (4)				
.710 - .745 (18.0 - 18.9)	2456-0002	.661 - .802	2457-0002 (4)				
.746 - .777 (18.9 - 19.7)	2456-0003	.689 - .830	2457-0003 (4)				
.778 - .870 (19.7 - 22.1)	2456-0004	.764 - .905	2457-0004 (4)				
.871 - .907 (22.1 - 23.0)	2456-0005	.786 - .927	2457-0005 (4)				
.908 - .959 (23.0 - 24.4)	2456-0006	.838 - .979	2457-0006 (4)				
.960 - .995 (24.4 - 25.3)	2456-0007	.874 - 1.015	2457-0007 (4)				
.996 - 1.032 (25.3 - 26.2)	2463-0004	.894 - 1.052	2464-0004 (4)	2600	1.000 - 1.218	2601 (4)	
1.033 - 1.084 (26.2 - 27.5)	2463-0005	.946 - 1.104	2464-0005 (4)				
1.085 - 1.120 (27.5 - 28.4)	2463-0007	.996 - 1.155	2464-0007 (4)				
1.121 - 1.245 (28.4 - 31.6)	2463-0009	1.106 - 1.265	2464-0009 (4)	2606	1.141 - 1.359	2610 (4)	
1.246 - 1.310 (31.6 - 33.3)	2470-0003	1.176 - 1.377	2471-0003 (6)				
1.252 - 1.300 (31.8 - 33.0)	2477-0001	1.170 - 1.330	2478-0001 (6)				
1.311 - 1.356 (33.3 - 34.4)	2470-0004	1.216 - 1.376	2471-0004 (6)				
1.301 - 1.482 (34.4 - 37.6)	2477-0004 2477-9004	1.300 - 1.501	2478-0004 (6)				
1.483 - 1.606 (37.6 - 40.8)	2477-0006	1.426 - 1.626	2478-0006 (6)				
	2477-9006						
1.607 - 1.704 (40.8 - 43.3)	2484-0003	1.493 - 1.724	2485-0003 (8)	2634	1.437 - 1.891	2639 (6)	7/16x14 (M)
1.705 - 1.760 (43.3 - 44.7)	2484-0006	1.623 - 1.854	2485-0006 (8)				
1.761 - 1890 (44.7 - 48.0)	2492-0006	1.712 - 1.946	2485-0003 (8)	2043	1.625 - 2.093	4115 (6)	9/16x12 (M)
	2493-0003						
1.891 - 1.954 (48.0 - 49.6)	2493-0005	1.780 - 2.014	2485-0005 (8)				
1.955 - 2.084 (49.6 - 52.9)	2493-0007	1.910 - 2.144	2485-0007 (8)				

\* To order bronze expanding brushes or bronze refill sets, change second half of (Part No. to "3XXX"). For nylon, change second half of (Part No. to "4XXX"). For stainless steel, ("5XXX"). Expanding brushes with ("900X") and "2XXX" Part Nos. have steel brushes and special adapters.

\*\* FF Adapter #6759 required to convert 7/16x14 (M) to 9/16x12 (F).

The **Wilson Expanding Scraper** complements the **Wilson Expanding Brush**, and it is recommended for removing soft, wet, or gummy deposits, such as mud or marine growth. The **Wilson Expanding Scraper** cleans tubes from 5/8-inch – 6½-inch (15.9 to 165.1mm) Outer Diameter. The blades in the **Wilson Expanding Scraper** do not fill with debris as they do when cleaning soft and gummy deposits with a brush, and they are easily and quickly replaced as they wear.

As the scraper head spins, the scraper blades lift up and scrape away deposits in the tube. The blades rise to conform to changes in the inside of the diameter of the tube, providing a very effective cleaning action throughout the length of the tube. The **Wilson Expanding Scraper** can be used with any **Wilson Electric, Pneumatic, or Air-Driven Tube Cleaning System**, and with a flexible holder it can be used to clean curved tubes, such as those found in water tube boilers.

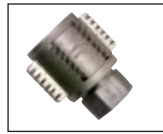
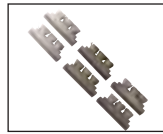
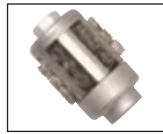
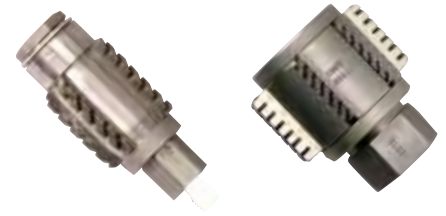

Tube ID Range Inches (mm)	Expanding Brush* Assembly	Cleaning Range Inches	Brush Refill Set* Part No. (#)	Expanding Scraper Assembly	Cleaning Range Inches	Scraper Refill Set Part No. (#)	Thread Male (M) Female (F)
2.000 - 2.124 (50.8 - 54.0)	3441-0001	1.834 - 2.279	3445-0001 (6)	7985-2416	1.750 - 2.250	7997 (5)	9/16 x 12 (F)
	3442-0001						5/8 x 11 (F)
	2494-0007						
2.125 - 2.249 (54.0 - 57.1)	3441-0003	1.896 - 2.341	3445-0003 (6)	7986-2416	1.875 - 2.375	8008 (5)	9/16 x 12 (F)
	3442-0003						5/8 x 11 (F)
	3444-0003						3/4 x 10 (F)
2.250 - 2.374 (57.1 - 60.3)	3441-0005	1.998 - 2.443	3445-0005 (6)	7987-2416	2.000 - 2.500	8009 (5)	9/16 x 12 (F)
	3442-0005						5/8 x 11 (F)
	3444-0005						3/4 x 10 (F)
2.375 - 2.499 (60.3 - 63.5)	3441-0008	2.146 - 2.591	3445-0008 (6)	7988-2416	2.125 - 2.625	8010 (5)	9/16 x 12 (F)
	3442-0008						5/8 x 11 (F)
	3441-0010						9/16 x 12 (F)
2.500 - 2.624 (63.5 - 66.6)	3442-0010	2.248 - 2.693	3445-0010 (6)	7989-3073	2.187 - 2.812	8009 (6)	5/8 x 11 (F)
	3444-0010						3/4 x 10 (F)
							3/4 x 10 (F)
2.625 - 2.749 (66.6 - 69.8)	3456-0002	2.417 - 2.825	3458-0002 (6)	7990-2354	2.312 - 2.937	8010 (6)	3/4 x 10 (F)
	3457-0002						7/8 x 9 (F)
							7/8 x 9 (F)
2.750 - 2.874 (69.8 - 73.0)	3456-0003	2.605 - 3.013	3458-0003 (6)	7991-3077	2.375 - 3.125	8016 (5)	3/4 x 10 (F)
	3457-0003						7/8 x 9 (F)
							7/8 x 9 (F)
2.875 - 2.999 (73.0 - 76.2)	3456-0004	2.667 - 3.075	3458-0004 (6)	7991-3077	2.375 - 3.125	8016 (5)	3/4 x 10 (F)
	3457-0004						7/8 x 9 (F)
							7/8 x 9 (F)
3.000 - 3.124 (76.2 - 79.3)	3470-0002	2.782 - 3.233	3473-0002 (6)	7992-3080	2.625 - 3.375	8019 (6)	3/4 x 10 (F)
	3471-0002						1 x 14 (F)
							3/4 x 10 (F)
3.125 - 3.249 (79.3 - 82.5)	3470-0004	2.874 - 3.325	3473-0004 (6)	7992-3080	2.625 - 3.375	8019 (6)	3/4 x 10 (F)
	3471-0004						7/8 x 9 (F)
							3/4 x 10 (F)
3.250 - 3.374 (82.5 - 85.7)	3470-0006	3.166 - 3.617	3473-0006 (6)	7993-3080	2.875 - 3.625	8022 (6)	7/8 x 9 (F)
	3471-0006						1 x 14 (F)
	3471-9004						3/4 x 10 (F)
3.375 - 3.499 (85.7 - 88.9)	3470-0007	3.236 - 3.687	3473-0007 (6)	7993-3080	2.875 - 3.625	8022 (6)	3/4 x 10 (F)
	3471-0007						7/8 x 9 (F)
	3470-0009						3/4 x 10 (F)
3.500 - 3.749 (88.9 - 95.2)	3471-0009	3.374 - 3.825	3473-0009 (6)	7993-3080	3.125 - 3.875	8026 (6)	7/8 x 9 (F)
	3471-9007						1 1/8 x 12 (F)
							3/4 x 10 (F)
3.750 - 3.999 (95.2 - 101.6)	4060-0003	3.543 - 4.047	3458-0003 (6)	7995-3081	3.375 - 4.125	8027 (6)	3/4 x 10 (F)
	4060-9003						1 1/8 x 12 (F)
							7/8 x 9 (F)
4.000 - 4.249 (101.6 - 107.9)	4060-0007	3.729 - 4.233	3458-0007 (6)	3571-4021	3.625 - 4.375	3573 (6)	7/8 x 9 (F)
	4060-9007						1 1/8 x 12 (F)
							7/8 x 9 (F)
4.250 - 4.499 (107.9 - 114.3)	3497-0437	3.988 - 4.875	2173-0437 (6)	3574-4021	3.875 - 4.635	3575 (6)	7/8 x 9 (F)
	3497-9437						1 1/8 x 12 (F)
							7/8 x 9 (F)
4.500 - 4.999 (114.3 - 127.0)	3497-0500	4.125 - 5.062	2173-0050 (6)	3576-4021	4.000 - 5.000	3580 (8)	1 1/8 x 12 (F)
	3497-9500						
5.000 - 5.499 (127.0 - 139.7)	3500-0500	4.562 - 5.625	2173-0050 (6)	3578-3513	4.500 - 5.500	3580 (8)	1 1/8 x 12 (F)
	3500-9437						
	3500-8437						
5.500 - 5.999 (139.7 - 152.4)	61312-0500	5.187 - 6.125	2173-0050 (8)	3581-3585	5.500 - 6.500	3583 (8)	1 1/8 x 12 (F)
	61312-0000						
6.000 - 6.499 (152.4 - 165.1)	3504-0500	5.562 - 6.625	2173-0050 (8)	3581-2709	5.500 - 6.500	3583 (8)	1 1/8 x 12 (F)
	3504-0437						



## Boiler Steel Spiral Brushes



Tube ID Range		Steel Spiral Brush*	Stainless Steel Spiral Brush*	Brass Spiral Brush*	Nylon Spiral Brush*	Thread*
Inches	(mm)					Male (M)
1.250 - 1.400	(31.8 - 38.1)	62540-0125	62540-2125	62540-3125	62540-4125	1/4 NPT (M)
1.500 - 1.749	(38.1 - 44.4)	62540-0150	62540-2150	62540-3150	62540-4150	
1.750 - 1.999	(44.5 - 50.8)	62540-0175	62540-2175	62540-3175	62540-4175	
2.000 - 2.249	(50.8 - 57.1)	62540-0200	62540-2200	62540-3200	62540-4200	
2.250 - 2.499	(57.2 - 63.5)	62540-0225	62540-2225	62540-3225	62540-4225	
2.500 - 2.749	(63.5 - 69.8)	62540-0250	62540-2250	62540-3250	62540-4250	
2.750 - 2.999	(69.9 - 76.1)	62540-0275	62540-2275	62540-3275	62540-4275	
3.000 - 3.249	(76.2 - 82.5)	62540-0300	62540-2300	62540-3300	62540-4300	
3.250 - 3.349	(82.6 - 88.9)	62540-0325	62540-2325	62540-3325	62540-4325	
3.500 - 3.749	(88.9 - 95.2)	62540-0350	62540-2350	62540-3350	62540-4350	
3.750 - 3.999	(95.3 - 101.6)	62540-0375	62540-2375	62540-3375	62540-4375	
4.000 - 4.250	(101.6 - 108.0)	62540-0400	62540-2400	62540-3400	62540-4400	

\* Requires adapter #9893 (9/16-Inch-12F x 1/4-Inch NPT), #9894 (3/4-Inch-10F x 1/4-Inch NPT), #9891 7/16-Inch-14F x 1/4-Inch NPT)

## Soot Brush

### Applications

- Removing Soot from 1½ – 4½-Inch (38.1 to 114.3mm) Outer Diameter Tubes in Fire Tube Boilers
- Attaches to Competing Drive Units



Tube ID Range		Steel Soot Brush	Thread
Inches	(mm)		Male (M)
1.250 - 1.499	(31.8 - 38.1)	62711-0125	1/2 x 12 (M)
1.500 - 1.749	(38.1 - 44.4)	62711-0150	
1.750 - 2.249	(44.5 - 57.1)	62711-0175	
2.225 - 2.749	(57.2 - 69.8)	62711-0225	
2.750 - 2.999	(69.9 - 76.2)	62711-0275	
3.000 - 3.249	(76.2 - 82.5)	62711-0300	
3.250 - 3.749	(82.6 - 95.2)	62711-0325	
3.750 - 4.250	(95.3 - 108.0)	62711-0375	

## U-Bend Cleaning Assemblies

### Applications

- Cleaning 3/4 – 1½-Inch (19.1 to 38.1mm) Outer Diameter Curved Tubes
- Use Stainless Steel Assembly to Clean Ferrous Tubes, Brass Cleaning Head for Nonferrous Tubes

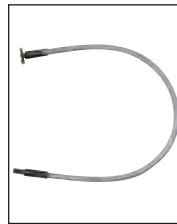

U-Bend Heat Exchanger Bundle

Tube ID Range	Assembly with Stainless Steel Cleaning Head	Assembly with Brass Cleaning Head	Cleaning Head Type	Diameter (Inches) (mm)	Drive Thread
.500 - .750 (12.7 - 19.1)	62690-0000	62690-5000	Cup Brush	3/4 (19.1)	1/4 x 28 (M)
.750 - 1.000 (19.1 - 25.4)	62660-0075	62660-1075	Wheel Brush	1 (25.4)	
1.000 - 1.250 (25.4 - 31.8)	62660-0100	62660-1100			

## Manual Tube Cleaning Extension Rods and Handles



Tube ID Range	Handle Part No.	Extension Rods Part No. (#)	Length Feet (M)
.160 - .250 (4.0 - 6.3)	62785-0001 (2 feet)	62785-0002 (2) (Steel with 3-48 Female Thread)	2 (0.6)
.250 - .375 (6.3 - 9.5)	62784-0001 (2 feet)	62784-0002 (2) (Steel with 8-32 Female Thread)	2 (0.6)
.375 - .500 (9.5 - 12.7)	62743	62744 (6) (Steel with 8-32 Female Thread)	2 (0.6)
.500 - 1.061 (12.7 - 26.9)	62741	62742 (6) (Steel with 1/4x28 Female Thread)	3 (0.9)
1.250 - 2.999 (31.8- 76.1)	62756	62748 (6)	3 (0.9)
		62749 (6)	4 (1.2)
		62750 (6) (Fiberglass with 1/4-Inch NPT Female)	6 (1.8)
3.000 - 4.250 (76.2- 108.0)	62757	62751† (6)	4 (0.9)
		62752† (6)	5 (1.2)
		62753† (6) (Fiberglass with 3/8-Inch NPT Female)	6 (1.8)

†For 3/8 NPT to 1/4 NPT Adapter use Part No. 6701

# Flexible Shafts & Casings

**Wils-Away™** Shafts & Casings are available in nylon, Teflon®, and steel. Smaller diameter casings are nylon (or Teflon®, if they will be run dry), and larger casings are steel. Shafts & Casings **Part No. 9726-XXXX** are designed for bi-direction (forward/reverse) cleaning, such as cleaning enhanced tubes with a spin grit or spin clean brush.



9720



9722



9724

Tube ID Range		Flexible Shaft & Casing Length		Flexible Shaft & Casing Part No.*	Casing Material	Shaft & Casing Diameter		Shaft Thread Male (M) or Female (F)
Inches	(mm)	Feet	(Meters)			Inches	(mm)	
.281 - .437	(7.1 - 11.1)	15	(4.6)	9720-0015	Nylon	1/4	(6.4)	8 x 32 (F)
		25	(7.6)	9722-0025				
.437 - .625	(11.1 - 15.9)	12	(3.7)	9722-6012	Teflon	3/8	(9.5)	1/4 x 28 (F)
		35	(10.7)	9722-0035				
		45	(13.7)	9722-0045				
		60	(18.3)	9722-0060				
.625 - 1.250	(15.9 - 31.8)	25	(7.6)	9724-0025	Nylon	1/2	(12.7)	1/4 x 28 (F)
		35	(10.7)	9724-0035				
		45	(13.7)	9724-0045				
		60	(18.3)	9724-0060				
.687 - 1.250	(17.5 - 31.8)	25	(7.6)	9724-6025	Teflon	9/16	(14.3)	9/16 x 12 (M)
		35	(10.7)	9726-0035				
		45	(13.7)	9726-0045				
		60	(18.3)	9726-0060				
1.250 - 1.500	(31.8 - 38.1)	25	(7.6)	9726-6025	Nylon	3/4	(19.1)	9/16 x 12 (M)
		35	(10.7)	9728-0035				
		45	(13.7)	9728-0045				
		60	(18.3)	9728-0060				
1.250 - 4.000	(31.8 - 101.6)	25	(7.6)	9728-6025	Steel	1 1/8	(27.0)	3/4 x 10 (M)
		30	(9.1)	9730-0030				
4.000 - 4.250	(101.6 - 108.0)	25	(7.6)	9730-9025	Rubber Coated Steel	1 1/8	(27.0)	3/4 x 10 (M)
		30	(9.1)	9730-0030				
		25	(7.6)	9732-0025				
		30	(9.1)	9732-0030	Steel	1 1/4	(31.8)	3/4 x 10 (M)

\* To order Shafts & Casings with **Wilson Smart Connect™** adapters, add "WC" to Part No. Maximum operating temperature: nylon 212°F, Teflon® 500°F.

## Wils-Away™ Accessories



**Twin Foot Pedal** Provides forward (clockwise) and reverse (counter clockwise) brush rotation for effective cleaning of enhanced tubes.

Part No.

9600-0015



**Safety Shaft Coupling** Prevents motor damage to **WAW-500** series drive units. These drive units are shipped with a spare Safety Shaft Coupling and a removal tool.

9600-0102



**Flexible Shaft Lubricator** Provides lubrication to Shaft & Casing Assembly, prolonging its life.

9675-0000



Steel Shaft  
9730-0025



Steel with Rubber Coating  
9730-9025

## Model A Cutter Heads



### MODEL A CUTTER HEADS

#### Applications

- Cleaning Straight or Curved 5/8 to 2½-Inch (15.9 - 63.5mm) Outer Diameter Tubes
- Removing Soft or Hard Scale of Thin to Medium Thickness

#### Smart Tool

- "No Track" cone cutter cleans tube by delivering glancing blows.
- Larger size cleaning heads also utilize cutter wheel for added cleaning capability.
- VUJ Universal Joint enables tool to clean curved tubes.
- Replacement cone cutters and cutter wheels keep this cleaning tool economical.

\* These Cutter Heads use *both* a Cone Cutter *and* one or two Cutter Wheels.



Tube ID Range Inches (mm)	Model A Cutter Head	Cone Cutter	Cutter Wheel	VUJ Universal Joint	M-M Adapter	Drive Thread
.500 - .624 (12.7 - 15.8)	7211-0000	36		2237	2545	10x28 (F)
	7211-9662				2545/9662	1/4x28 (M)
.625 - .749 (15.9 - 19.0)	7212-0000	35		2232	2546	10x28 (F)
	7212-9662				2546/9662	1/4x28 (M)
.750 - .874 (19.1 - 22.1)	7213-0000	19		3062	2547	12x24 (F)
	7213-9789				2547/9789	1/4x28 (M)
.875 - .999 (22.2 - 25.3)	7215-9665	20		2223	2548	5/16x18 (F)
	7215-0000			2227		1/4x20 (F)
1.000 - 1.124 (25.4 - 28.5)	7216-9665	21		2223	2548/9665	1/4x28 (M)
	7216-0000			2242		5/16x18 (F)
1.125 - 1.217 (28.6 - 30.8)	7220-0000	22		2218	2548	3/8x16 (F)
	7217-0000					2216
1.218 - 1.311 (30.9 - 33.2)	7282-0000	23		2216	2548/4385	9/16x12 (F)
	7282-4385					
1.312 - 1.499 (33.3 - 38.0)	5788-0000*	25	81 (2)	2212	5184	7/16x14 (F)
	7222-0000		-	2243		
1.500 - 1.749 (38.1 - 44.4)	5183-0000*	27	80 (2)	2212	5184	7/16x14 (F)
	7223-0000		-	2210		
1.750-1.999 (44.5 - 50.7)	7231-0000*	14		72 (1)	7210	7/16x14 (F)
	7225-0000*			2210		9/16x12 (F)
2.000-2.249 (50.8 - 57.0)	7224-0000		-	2140	3483	

## Model B Cutter Heads



### MODEL B CUTTER HEADS

#### Applications

- Cleaning Straight or Curved 5/8 to 2½-Inch (15.9 - 63.5mm) Outer Diameter Tubes
- Removing Soft or Hard Scale of Thin to Medium Uniform Thickness



Tube ID Range Inches (mm)	Model B Cutter Head	Cone Cutter	Type C Flex. Holder	M-M Adapter	Drive Thread
.500 - .624 (12.7 - 15.8)	8061	36	2261	2545	10x28 (F)
.625 - .749 (15.9 - 19.0)	8062	35		2546	
.750 - .874 (19.1 - 22.1)	8063	19	2265	2547	12x24 (F)
1.000 - 1.217 (25.4 - 30.8)	8066	21	2279	2548	5/16x18 (F)
1.218 - 1.311 (30.9 - 33.2)	8068	23	2303		
1.312 - 1.499 (33.3 - 38.0)	8069	25	2296	2550	7/16x14 (F)
1.500 - 1.749 (38.1-44.4)	8070	27			
1.750-1.999 (44.5-50.7)	8071	14	2862	3483	9/16x12 (F)
2.000-2.249 (50.8-57.0)	8075				

## Universal Joints

### MUJ



### VUJ



Male Thread	Female Thread	MUJ Univ Joint	Diameter Inches (mm)
7/16 x 14	7/16 x 14	4594	7/8 (22.2)
	9/16 x 12	9305	
9/16 x 12	7/16 x 14	7287	1 (25.4)
	9/16 x 12	7280	
	5/8 x 11	9306	
5/8 x 11	9/16 x 12	4653	1¼ (31.8)
	5/8 x 11	4606	
3/4 x 10	5/8 x 11	4650	1½ (38.1)
	3/4 x 10	4596	
	7/8 x 9	9308	
7/8 x 9	7/8 x 9	4644	1½ (38.1)
1½ x 12	1½ x 12	6558	2% (60.3)

Female Thread	Female Thread	VUJ Univ Joint	Diameter Inches (mm)
12 x 28	10 x 28	2237	3/8 (9.5)
		2232	7/16 (11.1)
5/16 x 18	12 x 24	3062	1/2 (12.7)
		1/4 x 20	2227
	5/16 x 18	2242	9/16 (14.3)
		2223	5/8 (15.9)
7/16 x 14	3/8 x 16	2218	3/4 (19.1)
	7/16 x 14	2243	
	5/16 x 18	2216	
9/16 x 12	7/16 x 14	2212	7/8 (22.2)
	5/8 x 11	2140	1 (25.4)
3/4 x 10	9/16 x 12	2180	1¼ (31.8)
	5/8 x 11	4555	
7/8 x 9	3/4 x 10	4952	1½ (38.1)
	7/8 x 9	2202	
1½ x 12	1 x 14	4950	1¾ (44.5)
	1½ x 12	2196	2 (50.8)
1½ x 12	1 x 14	9309	
		1½ x 12	2631
		3153	



# Cone Cutters



**Wilson Cone Cutters** and **Cutter Wheels** grind their way through the hardest deposits and scale. Their unique “no-track” design (their cutting edges are unevenly spaced) prevents them from skipping over or missing scale in the pipe or tube. Order Wilson Cone Cutters and Cutter Wheels from the chart of the cleaning head to which they will be attached.

Larger Diameter <i>Inches</i> <i>(mm)</i>	Cone Cutter	Thread <i>(Female)</i>	Hole Diam.
.438 (11.1)	36	10-32	-
.531 (13.5)	35	1/4 x 20	-
.625 (15.96)	30	-	.250
.656 (16.7)	19	1/4 x 20	-
.750 (19.1)	68	-	.312
	20	-	-
.812 (20.6)	21	5/16 x 18	-
.843 (21.4)	22	-	-
.875 (22.2)	63A	-	.312
	11	-	.250
.969 (24.6)	62A	-	.437
	23	5/16 x 18	-
1.000 (25.4)	13	-	.250
	64	-	.312
	69	-	-
	17	-	-
	86	-	.375
1.063 (27.0)	51A	-	.437
	61	-	-
	25	9/16 x 12	-
1.125 (28.6)	41	-	.312
	29	-	.375
1.250 (31.8)	50	-	.437
	27	9/16 x 12	-
1.375 (34.9)	57	-	.500
1.438 (36.5)	66	-	.437
1.500 (42.9)	48	-	.437
	14	9/16 x 12	-
1.688 (42.9)	15	-	.437
1.750 (44.5)	32	-	.562
2.000 (50.8)	2	-	.562

# Flexible Holders

**Type C Flexible Holders** enable **Wilson Cleaning Heads** to be used in curved tubes and pipes. Most often used with a cone cutter as its cleaning head, the Type C Flexible Holder and cone cutter use a whipping action to break free brittle or hard deposits and scale.

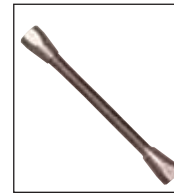

Tube ID Range <i>Inches</i> <i>(mm)</i>	Flexible Holder	Female Thread	Female Thread
.500 - .749 (12.7 - 19.0)	2261	10 x 28	12 x 28
	2434	12 x 28	
.750 - .780 (19.1 - 19.8)	2265	12 x 24	5/16 x 18
.781 - .874 (19.8 - 22.2)	2271	1/4 x 20	
.875 - 1.124 (22.2 - 28.5)	2279	5/16 x 18	
1.125 - 1.218 (28.6 - 30.9)	2285	3/8 x 16	
1.219 - 1.311 (31.0 - 33.3)	2303	7/16 x 14	
1.312 - 1.499 (33.3 - 38.1)	2296	-	7/16 x 14
1.500 - 2.000 (38.1 - 50.8)	2862	9/16 x 12	9/16 x 12

# Cutter Wheels



Diameter <i>Inches</i> <i>(mm)</i>	Cutter Wheel	Thickness <i>Inches</i>	Hole Diam.
.594 (15.1)	16	.312	.250
.750 (19.1)	24	.312	.312
.875 (22.2)	83	.125	.312
	37	.312	.437
.969 (24.6)	82	.156	.437
	44	.312	.312
1.000 (25.4)	26	.312	.437
1.063 (27.0)	81	.156	.437
1.250 (31.8)	80	.312	.437
1.375 (34.9)	65	.422	.500
1.500 (38.1)	72	.500	.437
1.750 (44.5)	73	.500	.562

# Drill Heads

**Wilson Drill Heads** remove hard or brittle scale, and are attached to a Type C Flexible Holder or universal joint.



Tube ID Range <i>Inches</i> <i>(mm)</i>	Drill Head	Male Thread
1.375 - 1.749 (28.6 - 33.3)	409	7/16 x 14
1.750 - 1.999 (33.3 - 39.6)	408	9/16 x 12
2.000 - 2.249 (39.6 - 44.4)	407	
2.250 - 2.499 (44.5 - 49.2)	406	5/8 x 11
2.500 - 2.999 (49.2 - 59.5)	405	3/4 x 10
3.000 - 3.499 (59.5 - 63.5)	403	7/8 x 9
3.500 - 3.999 (88.9 - 101.6)	402	
4.000 - 4.499 (101.6 - 114.3)	401	
4.500 - 6.250 (114.3 - 158.8)	400	1 1/2 x 12

## Model SE Cutter Heads

### Applications

- Cleaning Straight and Curved Tubes in Boilers and Large Diameter Pressure Vessels
- 1¼ – 6½-Inch (44.5 to 165.1mm) Outer Diameter Tubes
- Removing Hard-to-Get-At Medium to Extra Thick Gummy Deposits

### Smart Tool

- Offset, self-feeding cone cutters break up scale and clean in close where other cleaning heads would fail.
- Shipped with adapter for cleaning straight tubes or universal joint to clean curved tubes.
- Select Part No. by determining tube Inner Diameter, finding straight or curved column, and matching female drive thread to the male thread of the drive unit to which the Model SE Cutter Head will be attached.
- Prolong the life of the Model SE Cutter Head by ordering extra cone cutters.

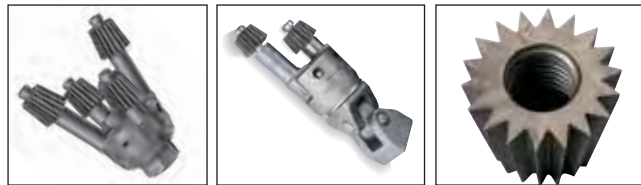

Tube ID Range Inches (mm)	SE Cutter Head Assembly (Straight Tubes)	SE Cutter Head Assembly (Curved Tubes)	Cone Cutter(s) Part No. (#)	Drive Thread	Cleaning Range (In.) Min. – Max.	Weight lbs (Kg)
1.375 - 1.749 (34.9 - 44.4)	4007	-	86A (1)	7/16 x 14 (F)	1¼ – 1¾	9/16 (.25)
1.750 - 1.999 (44.5 - 50.8)	4593-4384	4593-4594	63A (2)	9/16 x 12 (F)	1½ – 2	3/4 (.34)
	4593-4385	4593-9305		7/16 x 14 (F)		
2.000 - 2.124 (50.8 - 54.0)	9355-3997	9355-7287	64 (2)	9/16 x 12 (F)	1¾ – 2¼	1 (0.51)
	9355-3996	9355-7280		5/8 x 11 (F)		
2.125 - 2.374 (54.0 - 60.3)	4599-3954	4599-4653	64 (2)	9/16 x 12 (F)	1¾ – 2½	1¼ (.57)
	4599-4382	4599-4606		5/8 x 11 (F)		
2.375 - 2.874 (60.3 - 73.0)	4599-2706	4599-6429	64 (3)	3/4 x 10 (F)	2⅝ – 3	1 (0.74)
	4595-4032	4595-4650		5/8 x 11 (F)		
2.875 - 3.124 (73.0 - 79.4)	4595-6518	4595-4596	17 (4)	3/4 x 10 (F)	2⅝ – 3¼	2¼ (1.0)
	4595-4024	4595-9308		7/8 x 9 (F)		
3.125 - 3.999 (79.4 - 101.6)	4632-4032	4632-4650	29 (4)	5/8 x 11 (F)	2⅝ – 4	2½ (1.1)
	4632-6518	4632-4596		3/4 x 10 (F)		
4.000 - 4.249 (101.6 - 108.0)	4632-4024	4632-9308	66 (4)	7/8 x 9 (F)	3¾ – 4½	5½ (2.5)
	4640-2705	4640-4656		1 x 14 (F)		
4.250 - 5.249 (108.0 - 133.3)	4640-6919	4640-4644	32 (4)	7/8 x 9 (F)	4⅞ – 6½	10 (4.5)
	4640-4022	-		1 x 14 (F)		
5.250 - 6.000 (133.4 - 177.8)	3971-3081	3971-2196	66 (4)	7/8 x 9 (F)	3¾ – 4½	5½ (2.5)
	3971-3082	3971-9309		1 x 14 (F)		
4.250 - 5.249 (108.0 - 133.3)	3971-2376	3971-2631	66 (4)	1½ x 12 (F)	3¾ – 5½	7¼ (3.3)
	4117-3081	4117-2196		7/8 x 9 (F)		
4.250 - 5.249 (108.0 - 133.3)	4117-3082	4117-9309	32 (4)	1 x 14 (F)	4⅞ – 6½	10 (4.5)
	4117-2376	4117-2631		1½ x 12 (F)		
5.250 - 6.000 (133.4 - 177.8)	4121-6146	4121-6168	32 (4)	7/8 x 9 (F)	4⅞ – 6½	10 (4.5)
	4121-3083	4121-9310		1 x 14 (F)		
5.250 - 6.000 (133.4 - 177.8)	4121-3084	4121-3153	32 (4)	1½ x 12 (F)	4⅞ – 6½	10 (4.5)
	4121-3085	4121-8733		1½ x 12 (F)		

# Model R Cutter Heads



## Applications

- Cleaning Straight and Curved Tubes such as Those Found in Refineries, Breweries, and Food and Paper Plants
- 1¼ – 12-Inch (44.5 to 304.8 mm) Outer Diameter Tubes
- Removing Heavy Hard Deposits

## Smart Tool

- A series of cone cutters expand with centrifugal force, conforming to the Inner Diameter of the tube, breaking up scale.
- No-Track design cone cutters ensure thorough cleaning.
- Can be mounted to flexible coupling or universal joint to negotiate around curved tubes.
- Select Part No. by determining tube Inner Diameter and matching female drive thread to the male thread of the drive unit to which the Model R Cutter Head will be attached.
- Prolong the life of the Model R Cutter Head by ordering extra cone cutters and cutter wheels.

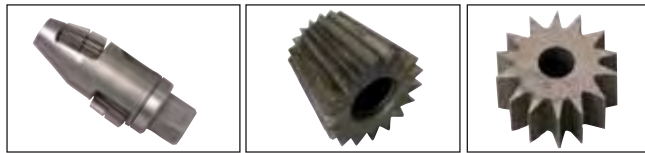

Straight Tube ID Range Inches (mm)	Model R Cutter Head Assembly	Cone Cutter(s)		Cutter Wheels		Drive Thread	Cleaning Range (In.) Min. – Max.	Weight	
		Part No.	(#)	Part No.	(#)			lbs	(Kg)
1.500 - 1.624 (38.1 - 41.2)	7496	41	(1)	10	(4)	7/16 x 14 (F)	1½ – 1⅞	15/16	(.4)
1.625 - 1.749 (41.3 - 44.4)	7508			12	(4)		1	(.5)	
1.750 - 1.874 (44.4 - 47.6)	7494-2411 7494-4127	11	(1)	10	(3)	9/16 x 12 (F) 5/8 x 11 (F)	1% – 2	1%	(.6)
1.875 - 1.999 (47.6 - 50.8)	7499-2411 7499-4127	13	(1)	12	(3)	9/16 x 12 (F) 5/8 x 11 (F)	1¼ – 2½	1¼	(.7)
2.000 - 2.249 (50.8 - 57.1)	7509-2416 7509-4130					5/8 x 11 (F) 3/4 x 10 (F)	1⅜ – 2¼	1½	(.8)
2.250 - 2.499 (57.1 - 63.5)	- 9311-2354	11	(1)	10	(1)	3/4 x 10 (F)	2¼ – 2%	2¼	(.9)
2.500 - 2.749 (63.5 - 69.8)	7329-2354 7329-2708	69	(3)	58	(6)	7/8 x 9 (F)	2¼ – 2%	2%	(1.2)
2.750 - 2.999 (69.9 - 76.2)	- 7334-2360						2¾ – 3%	3%	(1.5)
3.000 - 3.249 (76.2 - 82.5)	7512-3080 7512-2366	50	(3)	55	(6)	1 x 14 (F) 7/8 x 9 (F)	2% – 3%	5	(2.3)
3.250 - 3.499 (82.6 - 88.9)	7479-3080 7479-2366					1 x 14 (F)	3 – 3%	5½	(2.4)
3.500 - 3.749 (88.9 - 95.2)	7339-3082 7339-2376	66	(3)	71	(3)	1 x 14 (F) 1½ x 12 (F)	3¾ – 3⅝	5%	(2.6)
3.750 - 3.999 (95.3 - 101.6)	7474-3082 7474-2376	48	(3)	72	(3)	1 x 14 (F) 1½ x 12 (F)	3¾ – 4½	7%	(3.4)
4.000 - 4.499 (101.6 - 114.3)	7344-3082 7344-2376	15	(3)	56	(3)	1 x 14 (F) 1½ x 12 (F)	3% – 4%	8%	(4.0)
4.500 - 4.999 (114.3 - 127.0)	7349-3082 7349-2376					1 x 14 (F) 1½ x 12 (F)	4¾ – 5¾	11½	(5.2)
5.000 - 5.249 (127.0 - 133.3)	- 7482-2376	32	(3)	73	(6)	1½ x 12 (F)	4½ – 5¾		
5.250 - 5.749 (133.4 - 146.0)	8400-3084 8400-3085	32	(3)	73	(6)	1½ x 12 (F) 1½ x 12 (F)	4% – 5⅞		
5.250 - 5.749 (133.4 - 146.0)	7485-3084 7485-3085					1½ x 12 (F) 1½ x 12 (F)	4% – 5⅞		
5.750 - 6.249 (146.0 - 158.7)	8402-3085 7488-3085	32	(3)	73	(6)	1½ x 12 (F)	5½ – 6¾		
6.250 - 6.749 (158.8 - 171.4)	8404-3085 7491-3085	32	(4)	73	(8)		5% – 6⅞		
6.750 - 7.999 (171.5 - 203.2)	8406-3085 8257-3085	2	(3)	3	(6)	1½ x 12 (F)	6¾ – 7⅞		
8.000 - 9.499 (203.2 - 241.3)	8258-3085	2	(4)	3	(8)		7% – 9½		
9.500 - 11.500 (241.3 - 292.1)	8259-3085	2	(4)	3	(8)		9% – 11%		



## Model CHJ Cutter Heads

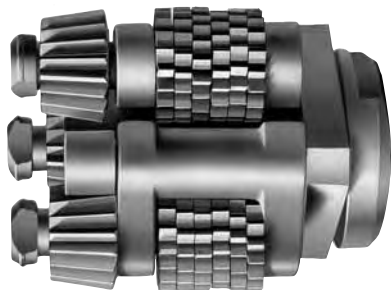

### Applications

- Cleaning Straight and Curved Tubes in Boilers and Large Diameter Pressure Vessels
- 1½ – 23-Inch (44.5 to 584.2mm) Outer Diameter Straight Tubes
- 2½ – 7-Inch (63.5 to 177.8mm) Outer Diameter Curved Tubes
- Removing Hard Scale and Encrustation

### Smart Tool

- Swing frame design utilizes arms with cone cutters and cutter wheels that cover a wide Inner Diameter range.
- Shipped with adapter for cleaning straight tubes or universal joint to clean curved tubes.
- Select Part No. by determining tube Inner Diameter, finding straight or curved column, and matching female drive thread to the male thread of the drive unit to which the Model CHJ Cutter Head will be attached.
- Extend the life of the Model CHJ Cutter Head by ordering extra cone cutters and cutter wheels.



Straight Tube ID Range Inches (mm)	Model CHJ Cutter Head Assembly	Cone Cutter		Cutter Wheel		Drive Thread	Cleaning Range (In.) Min. – Max.	Weight	
		Part No.	(#)	Part No.	(#)			lbs	(Kg)
1.375 - 1.749 (34.9 - 44.4)	4376-4384	30	(2)	16	(4)	7/16 x 14 (F)	1½ – 1¾	5/8	(.3)
	4376-4385					9/16 x 12 (F)			
1.750 - 1.999 (44.5 - 50.8)	4261-3997	68	(2)	24	(4)	7/16 x 14 (F)	1½ – 2¼	7/8	(.4)
	4261-3996					9/16 x 12 (F)			
2.000 - 2.124 (50.8 - 54.0)	4195-3954	63A	(2)	37	(4)	9/16 x 12 (F)	1½ – 2½	1½	(.7)
	4195-4382					5/8 x 11 (F)			
	4195-2706					3/4 x 10 (F)			
2.125 - 2.374 (54.0 - 60.3)	4344-3954	62A	(2)	44	(4)	9/16 x 12 (F)	2 – 2½	1½	(.8)
	4344-4382					5/8 x 11 (F)			
	4344-2706					3/4 x 10 (F)			
2.375 - 2.624 (60.3 - 66.7)	3203-4032	63A	(3)	83	(18)	5/8 x 11 (F)	2½ – 3¾	2½	(.9)
	3203-6518					3/4 x 10 (F)			
	3203-4024					7/8 x 9 (F)			
2.625 - 3.124 (66.7 - 79.4)	3209-6518	62A	(3)	82	(18)	3/4 x 10 (F)	2½ – 4¾	2¾	(1.2)
	3209-4024					7/8 x 9 (F)			
	3209-4023					1 x 14 (F)			
3.125 - 3.499 (79.4 - 88.9)	3215-2705	61	(3)	81	(18)	3/4 x 10 (F)	2½ – 4½	3½	(1.6)
	3215-6919					7/8 x 9 (F)			
	3215-4022					1 x 14 (F)			
3.500 - 4.249 (88.9 - 108.0)	3219-6919	50	(3)	80	(18)	7/8 x 9 (F)	3½ – 5	3¾	(1.7)
	3219-4022					1 x 14 (F)			
	3219-4021					1½ x 12 (F)			
4.250 - 5.249 (108.0 - 133.3)	3226-3511	57	(3)	65	(12)	7/8 x 9 (F)	4 – 6	8½	(3.8)
	3226-3512					1 x 14 (F)			
	3226-3513					1½ x 12 (F)			
5.250 - 6.999 (133.4 - 177.8)	2174-3514	57	(3)	65	(12)	1 x 14 (F)	5½ – 6½	9½	(4.3)
	2174-2709					1½ x 12 (F)			
	2174-3585					1½ x 12 (F)			
7.000 - 8.999 (177.8 - 228.6)	3865-4509	32	(4)	73	(8)	1½ x 12 (F)	6½ – 9¾	13¾	(6.0)
	3865-4437					1½ x 12 (F)			
9.000 - 11.99 (228.6 - 304.8)	7726-4509	32	(4)	73	(8)	1½ x 12 (F)	7 – 10½	14	(6.4)
	7726-4437					1½ x 12 (F)			
12.00 - 15.99 (304.8 - 406.4)	4744-4509	32	(6)	73	(12)	1½ x 12 (F)	10½ – 16	24¾	(11.0)
	4744-4437					1½ x 12 (F)			
16.00 - 17.99 (406.4 - 457.2)	5171-4437	32	(6)	73	(12)	1½ x 12 (F)	13¾ – 18½	27½	(12.5)
18.00 - 22.00 (457.2 - 558.8)	7402-4437	32	(4)	73	(8)	1½ x 12 (F)	16¾ – 21½	23½	(10.7)

## Model CHJ Cutter Heads (Curved Tubes)



Curved Tube ID Range Inches (mm)	Model CHJ Cutter Head Assembly	Cone Cutter		Cutter Wheel		Drive Thread	Cleaning Range (In.) Min. - Max.	Weight lbs (Kg)
		Part No.	(#)	Part No.	(#)			
2.000 - 2.374 (50.8 - 60.3)	4195-4653	63A	(2)	37	(4)	9/16 x 12 (F)	1 <sup>1</sup> / <sub>16</sub> - 2 <sup>1</sup> / <sub>16</sub>	1 <sup>1</sup> / <sub>2</sub> (.8)
	4195-4606					5/8 x 11 (F)		
	3203-4650					5/8 x 11 (F)		
2.375 - 2.874 (60.3 - 73.0)	3203-4596	63A	(3)	83	(18)	3/4 x 10 (F)	2 <sup>1</sup> / <sub>16</sub> - 3 <sup>1</sup> / <sub>16</sub>	2 <sup>1</sup> / <sub>2</sub> (1.0)
	3230-4650					5/8 x 11 (F)		
	3230-4596					3/4 x 10 (F)		
2.875 - 3.499 (73.0 - 88.9)	3230-9308	62A	(3)	82	(18)	7/8 x 9 (F)	2 <sup>1</sup> / <sub>2</sub> - 4 <sup>1</sup> / <sub>2</sub>	3 <sup>3</sup> / <sub>16</sub> (1.4)
	3237-4656					3/4 x 10 (F)		
	3237-4644					7/8 x 9 (F)		
3.500 - 4.249 (88.9 - 107.9)	3237-9966	51A	(3)	81	(18)	7/8 x 9 (F)	2 <sup>3</sup> / <sub>4</sub> - 4 <sup>1</sup> / <sub>2</sub>	3 <sup>3</sup> / <sub>4</sub> (1.5)
	3226-6558					1 <sup>1</sup> / <sub>2</sub> x 12 (F)		
4.250 - 5.249 (108.0 - 133.2)	2174-7274	57	(3)	65	(12)	1 <sup>1</sup> / <sub>2</sub> x 12 (F)	4 - 6	11 <sup>1</sup> / <sub>2</sub> (5.1)
5.250 - 6.500 (133.4 - 165.1)	2174-5317					1 <sup>1</sup> / <sub>2</sub> x 12 (F)		

## Swing Frame Brushes

### Applications

- Cleaning Straight and Curved Tubes in Large Diameter Pressure Vessels
- 3 - 21-Inch (76.2 - 533.4) Outer Diameter Tubes
- Removing Light Soot, Mill Scale, and Welding Splatter or Flash

### Smart Tool

- Brushes swing out as unit spins, so each assembly covers a wide cleaning range.
- Easily replaceable brush refill cartridges keep unit economical.
- Optional ball bearing swivel cable attachment enables swing frame brush to be pulled through the tube to expedite cleaning.

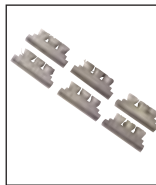

Tube ID Range Inches (mm)	Brush Assembly	Set of Refill Brushes (#)	Swivel Cable Attachment	Adapter	Drive Thread	Cleaning Range (In.) Min. > Max.	Weight lbs (Kg)	
2.688 - 2.874 (68.3 - 73.0)	4824-0031	4827-0031 (3)	61029	61427-0002	5/8 x 11 (F)	2 <sup>1</sup> / <sub>16</sub> - 3 <sup>3</sup> / <sub>4</sub>	1 (.5)	
2.875 - 3.499 (76.3 - 88.9)	4824-0040	4827-0040 (3)				2 <sup>1</sup> / <sub>16</sub> - 3 <sup>15</sup> / <sub>16</sub>		
3.500 - 3.687 (88.9 - 93.6)	4829-0040	4832-0040 (3)				3 <sup>1</sup> / <sub>2</sub> - 5		
3.688 - 3.937 (93.7 - 100.0)	4829-0050	4832-0050 (3)			7/8 x 9 (F)	3 <sup>1</sup> / <sub>16</sub> - 5 <sup>1</sup> / <sub>16</sub>	1 <sup>1</sup> / <sub>2</sub> (.8)	
3.938 - 4.499 (100.0 - 114.3)	4829-0062	4832-0062 (3)				3 <sup>15</sup> / <sub>16</sub> - 5 <sup>1</sup> / <sub>16</sub>		
4.500 - 4.687 (114.3 - 119.0)	61427-0040	4832-0040 (3)				4 <sup>1</sup> / <sub>2</sub> - 6		
4.688 - 5.437 (119.1 - 138.1)	61427-0050	4832-0050 (3)		61029	6923	1 x 14 (F)	4 <sup>1</sup> / <sub>16</sub> - 6 <sup>1</sup> / <sub>16</sub>	2 (.9)
5.438 - 5.874 (138.1 - 149.2)	4834-0040	4837-0040 (4)					5 <sup>1</sup> / <sub>16</sub> - 7	
5.875 - 6.437 (149.2 - 163.5)	4834-0062	4837-0062 (4)					5 <sup>1</sup> / <sub>16</sub> - 7 <sup>1</sup> / <sub>16</sub>	
6.438 - 7.124 (163.5 - 180.1)	61426-0040	4837-0040 (4)				-	6 <sup>1</sup> / <sub>16</sub> - 8	5% (2.6)
7.125 - 7.437 (180.1 - 188.9)	4839-0040	4837-0040 (4)				7 <sup>1</sup> / <sub>16</sub> - 9 <sup>1</sup> / <sub>16</sub>		
7.438 - 8.937 (188.9 - 227.0)	4839-0056	4837-0056 (4)				6923	7 <sup>1</sup> / <sub>16</sub> - 10 <sup>1</sup> / <sub>16</sub>	
8.938 - 10.374 (227.0 - 263.5)	8037-0056	4837-0056 (4)	6082	4437	1 <sup>1</sup> / <sub>2</sub> x 12 (F)	8 <sup>3</sup> / <sub>16</sub> - 11 <sup>1</sup> / <sub>16</sub>	14 <sup>1</sup> / <sub>2</sub> (6.4)	
10.375 - 14.374 (263.5 - 365.1)	7298-0040	7303-0040 (6)				10 <sup>1</sup> / <sub>16</sub> - 16 <sup>1</sup> / <sub>2</sub>		
14.375 - 20.500 (365.1 - 520.7)	7299-0040	7303-0040 (6)				14 <sup>1</sup> / <sub>16</sub> - 20 <sup>1</sup> / <sub>2</sub>		

### Applications

- Designed for Use with **PG, PGX-2, and TP-302** Drive Units
- **SPE-DUR Cutter Bit:** Carbide-Tipped Cutter Bit for General Purpose Cleaning
- **M Cutter Bit:** Twist Drill Type Cutter Bit with Carbide-tip to Clear Clogged Tubes
- **K Cutter Bit:** Also a Carbide-Tipped Cutter Bit for Larger Tubes
- **P Brush:** Light Cleaning or Finish-Up Cleaning After Using a **Cutter Bit** to Clean Heavily Blocked or Clogged Tubes  
Can Also Be Used with Push Rod to Clean Fire Tube Boilers

### Smart Tool

- Use **Wilson Cutter Bits** to clean heavily clogged tubes. Carbide tip literally cuts through hardest, heaviest debris, scale, and residue.
- Use **P Brush** for finishing up, removing scale broken free by **cutter bit**.
- For manual boiler cleaning, attach **P Brush** to push rod (page 27).
- If thread on **P Brush** or **cutter bit** does not match thread on drive motor, select adapter (Page 39).



M Cutter Bit

Tube ID Range Inches	Tube ID Range (mm)	P Brush (Steel)* Part No.	Diam. (Inches)	Male Thread	SPE-DUR Cutter Bit	Diam. (Inches)	Female Thread	M Cutter Bit	Diameter (Inches)	Thread			
.359 - .389	(9.1 - 9.9)	8543-0135	.343	8 x 32	7162	.343	12 x 28						
.390 - .420	(9.9 - 10.7)	8543-0138	.375										
.421 - .452	(10.7 - 11.5)	8543-0140	.406		7163	.406	1/4 x 28				7771	.468	1/4 x 28 (F)
.452 - .483	(11.5 - 12.3)	8543-0143	.437		7164	.468					7786	.500	5/16 x 24 (F)
.484 - .514	(12.3 - 13.1)	8543-0146	.468		7165	.500					7772	.562	
.515 - .545	(13.1 - 13.8)	8543-0150	.500		5/16 x 24	7166	.562				7773	.625	3/8 x 24 (F)
.546 - .577	(13.8 - 14.7)	8543-0153	.531			7167	.625				7774	.687	
.578 - .608	(14.7 - 15.4)	8543-0155	.562				7168					.687	
.609 - .639	(15.5 - 16.2)	8543-0159	.593			7169						.750	7776
.640 - .675	(16.2 - 17.2)	8544-0162	.625				7170				.812	7779	
.676 - .706	(17.2 - 17.9)	8544-0165	.656			7171					.875		7777
.707 - .737	(17.9 - 18.7)	8544-0167	.687	7172			.937	7791	1.000				
.738 - .769	(18.7 - 19.5)	8544-0171	.718			7173	1.000		7778	1.062			
.770 - .800	(19.6 - 20.3)	8544-0174	.750	7170			.812	7792		1.125			
.801 - .831	(20.4 - 21.1)	8544-0177	.781		7171	.875	7779		1.187				
.832 - .862	(21.1 - 21.9)	8544-0182	.812	7172		.937		7793	1.250				
.863 - .894	(21.9 - 22.7)	8544-0183	.843		7173	1.000	7780		1.312				
.895 - .925	(22.7 - 23.5)	8545-0186	.875	7172		.937		7703	1.375				
.926 - .956	(23.5 - 24.3)	8545-0190	.906		7173	1.000	7705		1.625				
.957 - .987	(24.3 - 25.1)	8545-0193	.937	7170		.812		7706	1.750				
.988 - 1.024	(25.1 - 26.0)	8545-0196	.968		7171	.875	7707		1.875				
1.025 - 1.055	(26.0 - 26.8)	8545-0200	1.000	7172		.937		7708	2.000				
1.056 - 1.086	(26.8 - 27.6)	8545-0203	1.031		7173	1.000	7703		1.375				
1.087 - 1.117	(27.6 - 28.4)	8545-0206	1.062	7170		.812		7705	1.625				
1.118 - 1.149	(28.4 - 29.2)	8545-0210	1.093		7171	.875	7706		1.750				
1.150 - 1.180	(29.2 - 30.0)	8545-0211	1.125	7172		.937		7707	1.875				
1.181 - 1.211	(30.0 - 30.8)	8545-0215	1.156		7173	1.000	7708		2.000				
1.212 - 1.242	(30.8 - 31.6)	8545-0218	1.187	7170		.812		7703	1.375				
1.243 - 1.280	(31.6 - 32.5)	8545-0220	1.218		7171	.875	7705		1.625				
1.281 - 1.374	(32.5 - 34.9)	8545-0225	1.250	7172		.937		7706	1.750				
1.375 - 1.436	(34.9 - 36.5)	8545-0230	1.312		7173	1.000	7707		1.875				
1.437 - 1.499	(36.5 - 38.1)	8545-0235	1.375	7170		.812		7708	2.000				
1.500 - 1.561	(38.1 - 39.6)	8542-0145	1.437		7171	.875	7703		1.375				
1.562 - 1.686	(39.6 - 42.8)	8542-0150	1.500	7172		.937		7705	1.625				
1.687 - 1.811	(42.8 - 46.0)	8542-0161	1.625		7173	1.000	7706		1.750				
1.812 - 1.936	(46.0 - 49.2)	8542-0175	1.750	7170		.812		7707	1.875				
1.937 - 2.061	(49.2 - 52.3)	8542-0188	1.875		7171	.875	7708		2.000				
2.062 - 2.186	(52.4 - 55.5)	8542-0194	2.000	7172		.937		7703	1.375				



K Cutter Bit

\* Other material available: bronze (-2xxx), nylon (-3xxx), and stainless steel (-4xxx).



# PG Accessories

## Applications

- **Bit and Shaft Assembly:** Used with PG Drive Unit (Page 10) to Clean Clogged 1/4 – 3/8-Inch (6.4 to 9.5mm) Outer Diameter Tubes
- **Brush and Shaft Assembly:** Also Used with PG Drive Unit to Clean Same Diameter Tubes or Do Finish Up Cleaning after Initial Cleaning with Bit and Shaft

## Bit and Shaft Assembly



## Brush and Shaft Assembly



Tube ID Range Inches (mm)	Shaft Length	Bit and Shaft Part No.	Bit Diameter	Shaft Diameter	Brush and Shaft (Stainless Steel)	Brush and Shaft (Bronze)	Brush and Shaft (Nylon)	Brush Diameter
.187 - .205 (4.7 - 5.2)	24 In.	61242-0024	.172	.156	62280-2124	62280-3124	62280-4124	.187
	36 In.	61242-0036			62280-2136	62280-3136	62280-4136	
	48 In.	61242-0048			62280-2148	62280-3148	62280-4148	
.206 - .304 (5.2 - 7.7)	24 In.	62327-0024	.187	.156	62430-2124	62430-3124	62430-4124	.218
	36 In.	62327-0036			62430-2136	62430-3136	62430-4136	
	48 In.	62327-0048			62430-2148	62430-3148	62430-4148	
.305 - .318 (7.7 - 8.1)	24 In.	60605-0024	.281	.250	62432-2124	62432-3124	62432-4124	.312
	36 In.	60605-0036			62432-2136	62432-3136	62432-4136	
	48 In.	60605-0048			62432-2148	62432-3148	62432-4148	
.319 - .350 (8.1 - 8.9)				.250	62433-2124	62433-3124	62433-4124	.328
					62433-2136	62433-3136	62433-4136	
					62433-2148	62433-3148	62433-4148	

# PGX-2, TP-302 Accessories

## Applications

- **Drill Shafting:** Extends Reach of the Cleaning Head when Cleaning Long Tubes. Add length in 5-foot increments.
- **Shaft Support:** Connects Drill Shafting to Motor beyond Taper Threads.

## Drill Shaft for PG/TP Series



## Shaft Support for PG/TP Series



Tube ID Range Inches (mm)	5-Foot Drill Shaft	10-Foot Drill Shaft	Shaft Thread	For PG	For PGX-2	For TP-302	PG	Drive Motor PGX-2	TP-302
.375 - .437 (9.5 - 11.1)	6207-0005	6207-0010	5/16 x 22	7019			7005		
.500 - .531 (12.7 - 13.5)	6208-0005	6208-0010	3/8 x 22	7022	7954				
.562 - .656 (14.3 - 16.7)	6209-0005	6209-0010	7/16 x 22		7955			9288	
.687 - .812 (17.4 - 20.6)	6210-0005	6210-0010	1/2 x 18		7956				
.875 - 1.187 (22.2 - 30.1)	6211-0005	6211-0010	5/8 x 18		7957	6225			9267
1.250 - 1.562 (31.8 - 39.7)	6212-0005	6212-0010	3/4 x 18		7958	6226			
1.625 - 2.625 (41.3 - 66.7)	6213-0005	6213-0010	7/8 x 18			6227			

Page 12

Page 12

Page 14

# Bit Adapters

## Applications

- Use adapter bits to Connect SPE-DUR, M, or K Cutter Bits, or P Brushes to Drill Shafts.
- Match Thread on drill shaft with Thread on cutter bit or P Brush.



Shaft Thread	112 x 28	SPE-DUR and M Cutter Bit Threads				K Bit Threads		P Brush Threads					
		1/4 x 28	5/16 x 24	3/8 x 24	7/16 x 20	1/2 x 20	5/8 x 18	1/2 x 20	5/8 x 18	8 x 32	10 x 32	5/16 x 24	5/8 x 11
5/16 x 22	7189									9275	8558		
3/8 x 22		7192	7193							9276	9279		
7/16 x 22			7194	7233							9280	9379	
1/2 x 22				7196				7715			9281	9283	
5/8 x 18					7199			7716	7718	9282	9284		
3/4 x 18					7288	7202	7203	7717	7719			9285	8568
7/8 x 18								7730	7720				8570

## Universal Expanding Brushes



### Applications

- Removing Soft or Powdery Deposits (Rust, Chemical Precipitates and Scale) from 1 – 2-Inch (25.4 to 50.8mm) Outer Diameter Curved Tubes
- Can Clean Tubes with Radius of Approximately 4 Times the Tube Outer Diameter
- Attach to Type SC Flexible Holder (below)

Tube ID Range Inches (mm)	Expanding Brush Assembly	Cleaning Range Inches	Drive Thread	Steel Refill Brush Set Part No. (#)
.710 - .745 (18.0 - 18.9)	2648-0001	.627 - .732	5/16 x 18 (M)	2649-0001 (4)
.746 - .777 (18.9 - 19.7)	2648-0002	.677 - .782		2649-0002 (4)
.778 - .870 (19.7 - 22.1)	2648-0004	.725 - .832		2649-0004 (4)
.871 - .907 (22.1 - 23.0)	2648-0005	.780 - .885		2649-0005 (4)
.908 - .959 (23.1 - 24.4)	2648-0006	.802 - .907		2649-0006 (4)
.960 - .995 (24.4 - 25.3)	2657-0001	.906 - .992		2658-0001 (4)
.996 - 1.032 (25.3 - 26.2)	2657-0002	.956 - 1.042		2658-0002 (4)
1.033 - 1.084 (26.2 - 27.5)	2657-0003	.984 - 1.070		2658-0003 (4)
1.085 - 1.120 (27.5 - 28.4)	2657-0004	1.031 - 1.117		2658-0004 (4)
1.121 - 1.245 (28.4 - 31.6)	2664-0001	1.042 - 1.242		2665-0001 (6)
1.246 - 1.310 (31.6 - 33.3)	2664-0003	1.092 - 1.292	2665-0003 (6)	
1.311 - 1.356 (33.3 - 34.4)	2671-0001	1.178 - 1.424	2665-0001 (6)	
1.357 - 1.482 (34.5 - 37.6)	2671-0003	1.228 - 1.474	2665-0003 (6)	
1.483 - 1.606 (37.6 - 40.8)	2678-0001	1.360 - 1.680	7/16 x 14 (M)	2679-0001 (6)
1.607 - 1.704 (40.8 - 43.3)	2678-0002	1.394 - 1.714	2679-0002 (6)	
1.705 - 1.760 (43.3 - 44.7)	2678-0004	1.472 - 1.792	2679-0004 (6)	
1.761 - 1.890 (44.7 - 48.0)	2678-0005	1.520 - 1.840	2679-0005 (6)	

## Sectional Brushes



### Applications

- Removing Rust, Polishing, and De-Burring Straight or Curved 1/4 – 3-Inch (31.8 to 76.2) Outer Diameter Tubes
- Replaceable Sets of Four Parallel Brushes are Economical and Easy to Install

Curved or Straight Tube ID Range Inches (mm)	Sectional Brush Assembly	Refill Set	Brush Mounting	Drive Thread	Brush Diameter Inches
.781 - .874 (19.8 - 22.2)	8353-0068	8347-0068	8317	5/16 x 18 (M)	11/16
.875 - .999 (22.2 - 25.4)	8353-0075	8347-0075			3/4
1.000 - 1.124 (25.4 - 28.5)	8353-0081	8347-0081			13/16
1.125 - 1.249 (28.6 - 31.7)	8354-0100	8348-0100	1		
1.250 - 1.499 (31.8 - 38.1)	8354-0106	8348-0106	9491	7/16 x 14 (M)	1 1/16
1.500 - 1.749 (38.1 - 44.4)	8356-0131	8349-0131	8319		1 5/16
1.750 - 1.999 (44.5 - 50.8)	8357-0156	8350-0156	8320		1 7/8
2.000 - 2.124 (50.8 - 54.0)	8358-0175	8350-0175	8321	9/16 x 12 (M)	1 3/4
2.125 - 2.374 (54.0 - 60.3)	8359-0200	8350-0200	8341	5/8 x 11 (M)	2
2.375 - 2.624 (60.3 - 66.6)	8360-0225	8351-0225	8344		2 1/4
2.625 - 2.874 (66.7 - 73.0)	8361-0250	8351-0250	8345	3/4 x 10 (M)	2 1/2



Universal Expanding Brush and Type SC Flexible Holder Cleaning a Curved Tube

## Type SC Flexible Holder



### Applications

- Attaches between Air Motor and Cleaning Head to Clean Curved Tubes
- Match Male Threads on Motor and Cleaning Head with Female Threads on Type SC Flexible Holder

Female Thread	Female Thread	Type SC Flexible Holder	Length Inches	Disc Diam. Inches
5/16 x 18	1/2 x 24	2268	6.750	.625
	1/4 x 20	2275		.688
	5/16 x 18	2281		.750
	3/8 x 16	2289		.813
7/16 x 14	7/16 x 14	2300	7.125	1.250

## Curved Tube Data

Nominal Tube ID Inches (mm)	Crush	Motor Model	Curved Tube Minimum Radii Universal Joint and Cutter Head Inches				Radii Flex. Hldr. and Brush Inches
			30° Arc Radius	60° Arc Radius	90° Arc Radius	90° Arc Radius	
.810 (20.1)	.050	C-2	5	6	7	7	
.907 (23.0)	.050	C-3	5	6	7	7	
1.010 (26.2)	.062	C-4	5	6	7	7	
1.135 (28.8)	.062	C-5	6	7	8	8	
1.260 (32.0)	.075	C-6	6	7	8	8	
1.482 (37.6)	.100	C-8	6	7	8	10	
1.704 (43.3)	.120	C-10	6	6	8	10	
1.954 (49.3)	.120	C-12	8	9	10	12	
2.170 (55.1)	.120	ECT-212	10	11	12	12	
2.420 (61.5)	.125	ECT-237	10	11	12	12	
2.670 (67.8)	.125	ECT-262	12	13	14	14	
2.890 (73.4)	.125	ECT-287	14	15	16	18	
2.982 (75.7)	.125	ECT-312	17	18	18	20	
3.482 (88.4)	.125	ECT-362	15	16	16	19	

# Adapters

## Applications

- Type HF Adapters (Cutter Head-to-Motor Shaft)
- Type MF Adapters (Male-to-Female)
- Type MM Adapters (Male-to-Male)
- Type FF Adapters (Female-to-Female-to Female)



Cleaning Head Thread	Motor Shaft Thread	Type HF Adapter	Hex.
9/16 x 12	7/16 x 14	9303	1
	9/16 x 12	2411	
	5/8 x 11	4127	
5/8 x 11	7/16 x 14	9304	7/8
	9/16 x 12	3070	
	5/8 x 11	2416	1
	3/4 x 10	4130	
3/4 x 10	9/16 x 12	6261	1%
	5/8 x 11	3073	
	3/4 x 10	2354	
	7/8 x 9	2708	
7/8 x 9	9/16 x 12	6262	1%
	5/8 x 11	3075	
	3/4 x 10	3077	
	7/8 x 9	2360	
1 x 14	9/16 x 12	9394	1 1/2
	3/4 x 10	3079	
	7/8 x 9	3080	
	1 x 14	2366	
1 1/2 x 12	3/4 x 10	6930	1%
	7/8 x 9	3081	
	1 x 14	3082	
	1 1/2 x 12	2376	
1 1/2 x 12	7/8 x 9	6146	2
	1 x 14	3083	
	1 1/2 x 12	3084	
	1 1/2 x 12	3085	

Male Thread	Female Thread	Type M-F Adapter	Hex.
8 x 32	10 x 32	9902	1/4
1/4 x 28	10 x 28	4141	3/8
5/16 x 24		4142	7/16
3/8 x 24	12 x 24	4143	9/16
1/4 x 28	12 x 28	9587	3/8
	5/16 x 18	9589	7/16
5/16 x 18	1/4 x 20	6801	
	5/16 x 18	6802	9/16
	3/8 x 16	6803	1/2
7/16 x 20	5/16 x 18	4144	5/8
	3/8 x 16	4145	9/16
	7/16 x 14	6744	11/16
7/16 x 20	7/16 x 14	4384	3/4
	9/16 x 12	4385	5/8
1/2 x 20	7/16 x 14	4146	
9/16 x 12	5/8 x 11	4147	1
	9/16 x 12	3997	
	7/16 x 14	4029	
5/8 x 11	9/16 x 12	3996	1 1/2
	7/16 x 14	5922	
	5/8 x 11	4382	
	9/16 x 12	3954	
3/4 x 10	3/4 x 10	2706	1%
	5/8 x 11	4032	
	3/4 x 10	6518	
	7/8 x 9	4024	
7/8 x 9	1 x 14	4023	1
	9/16 x 12	4178	
	5/8 x 11	5440	
	3/4 x 10	2705	
1 x 14	7/8 x 9	6919	1 1/2
	1 x 14	4022	
	7/8 x 9	4905	
	1 x 14	6923	
1 1/2 x 12	1 x 14	6923	1%
	1 1/2 x 12	4020	
1 1/2 x 12	1 x 14	3512	1 1/2
	1 1/2 x 12	3513	
1 1/2 x 12	1 x 14	3514	1%
	1 x 14	3514	



Male Thread	Male Thread	Type M-M Adapter	Hex.
8 x 32	1/2 x 28	9949	5/16
10 x 32		2545	
10 x 28	1/4 x 28	9662	3/8
12 x 24		9789	
12 x 28	1/4 x 20	2546	5/16
	1/4 x 28	9672	
1/4 x 20	5/16 x 18	6984	7/16
	1/4 x 28	9791	
1/4 x 28	5/16 x 18	9665	3/8
	1/4 x 28	9664	
	5/16 x 24	9950	
	3/8 x 24	9666	
1/4 x 20	7/16 x 20	9667	9/16
	5/16 x 18	2547	
5/16 x 18	5/16 x 18	2548	7/16
7/16 x 14	9/16 x 12	5184	5/8
		2550	
9/16 x 12	9/16 x 12	3483	3/4



Female Thread	Female Thread	Type F-F Adapter	Hex.
10 x 28	1/4 x 28	4148	3/8
12 x 24		4149	
5/16 x 18	9/16 x 12	4150	7/16
	3/8 x 16	9798	
7/16 x 14	7/16 x 14	4140	5/8
	1/2 x 20	9395	
	7/16 x 14	9010	
9/16 x 12	1/4 NPT	6759	3/4
	1/2 x 20	9893	
	9/16 x 12	9014	
	9/16 x 12	6760	
5/8 x 11	9/16 x 12	6761	13/16
	5/8 x 18	9017	
3/4 x 10	5/8 x 18	9019	1
		7/8 x 9	



# Air and Water Hoses



1 Braid



2 Braid



2 Braid Armored



5 Ply Armored



Hose		Hose		Hose Type	- Couplings -		Part No.	Weight		For Use with These Wilson Tube Cleaning Kits:																																																																																																																																																																			
Inches	(mm)	Feet	(meters)		Inches	(mm)		NPT	lbs.		(Kg)																																																																																																																																																																		
3/16	(4.8)	25	(6.4)	1 Braid	15/32	(11.9)	1/8 - 1/4*	2	(0.9)	MS-0, MS-1 * Motor end is 1/8, manifold end is 1/4 NPT																																																																																																																																																																			
		50	(12.7)					4	(1.8)		1/4	(6.4)	25	(6.4)	1 Braid	11/16	(17.5)	1/4	7040-0025	2½	(1.2)	MS-1A, MS-3, C-2, C-3	50	(12.7)	7040-0050	5½	(2.5)	25	(6.4)	2 Braid	7040-9025	3½	(1.6)	C-4	50	(12.7)	7040-9050	7	(3.2)	3/8	(9.5)	15	(3.8)	2 Braid	3/4	(19.1)	3/8	8042-0015	3	(1.4)	PG, PGX-2 (Scavenging)	2 Braid Armored	7079-0015	5	(2.3)	TP-302 (Scavenging)	25	(6.4)	2 Braid	7/8	(22.2)	3/8	8971-0025	5	(2.3)	MS-4, MS-5, C-5	50	(12.7)	8971-0050	10	(4.5)	25	(6.4)	2 Braid Armored	8972-0025	7	(3.2)	MS-6, MS-8, MS-10, EP-137, C-6, C-8, C-10	50	(12.7)	8972-0050	13	(5.9)	1/2	(12.7)	50	(12.7)	2 Braid	1	(25.4)	1/2	9600-0121	11	(5.0)	Wils-Away™ 9502 and 9800	25	(6.4)	8973-0025	8	(3.6)	50	(12.7)	2 Braid Armored	8973-0050	16	(7.3)	PG, Blo-Gun	25	(6.4)	8974-0025	10	(4.5)	50	(12.7)	8974-0050	20	(9.1)	3/4	(19.1)	25	(6.4)	2 Braid Armored	1½	(38.1)	3/4	8975-0025	14	(6.4)	EP-200 through 250, ECT-262, ECT 287, PGX-2	50	(12.7)	8975-0050	28	(12.7)	1	(25.4)	25	(6.4)	2 Braid Armored	1⅞	(46.0)	1	8976-0025	18	(8.2)	EP-257 through 350, ECT-312 through 650	50	(12.7)	8976-0050	35	(15.9)	25	(6.4)	5 Ply Armored	8623-0025	34	(15.4)	EP-225 through 1350, ECT-312 through 650, TP-302	50	(12.7)	8623-0050	70	(31.8)	1¼	(31.8)	25	(6.4)	6 Ply Armored	2½	(66.7)	1¼	8625-0025	45
1/4	(6.4)	25	(6.4)	1 Braid	11/16	(17.5)	1/4	7040-0025	2½	(1.2)			MS-1A, MS-3, C-2, C-3																																																																																																																																																																
		50	(12.7)					7040-0050	5½	(2.5)																																																																																																																																																																			
		25	(6.4)	2 Braid				7040-9025	3½	(1.6)			C-4																																																																																																																																																																
		50	(12.7)					7040-9050	7	(3.2)																																																																																																																																																																			
3/8	(9.5)	15	(3.8)	2 Braid	3/4	(19.1)	3/8	8042-0015	3	(1.4)	PG, PGX-2 (Scavenging)																																																																																																																																																																		
		2 Braid Armored	7079-0015	5				(2.3)	TP-302 (Scavenging)																																																																																																																																																																				
		25	(6.4)	2 Braid	7/8	(22.2)	3/8	8971-0025	5	(2.3)	MS-4, MS-5, C-5																																																																																																																																																																		
		50	(12.7)					8971-0050	10	(4.5)																																																																																																																																																																			
		25	(6.4)	2 Braid Armored				8972-0025	7	(3.2)	MS-6, MS-8, MS-10, EP-137, C-6, C-8, C-10																																																																																																																																																																		
		50	(12.7)					8972-0050	13	(5.9)																																																																																																																																																																			
1/2	(12.7)	50	(12.7)	2 Braid				1	(25.4)	1/2	9600-0121	11	(5.0)	Wils-Away™ 9502 and 9800																																																																																																																																																															
		25	(6.4)								8973-0025	8	(3.6)																																																																																																																																																																
		50	(12.7)	2 Braid Armored	8973-0050	16	(7.3)				PG, Blo-Gun																																																																																																																																																																		
		25	(6.4)		8974-0025	10	(4.5)																																																																																																																																																																						
		50	(12.7)		8974-0050	20	(9.1)																																																																																																																																																																						
3/4	(19.1)	25	(6.4)	2 Braid Armored	1½	(38.1)	3/4	8975-0025	14	(6.4)	EP-200 through 250, ECT-262, ECT 287, PGX-2																																																																																																																																																																		
		50	(12.7)					8975-0050	28	(12.7)																																																																																																																																																																			
1	(25.4)	25	(6.4)	2 Braid Armored	1⅞	(46.0)	1	8976-0025	18	(8.2)	EP-257 through 350, ECT-312 through 650																																																																																																																																																																		
		50	(12.7)					8976-0050	35	(15.9)																																																																																																																																																																			
		25	(6.4)	5 Ply Armored				8623-0025	34	(15.4)	EP-225 through 1350, ECT-312 through 650, TP-302																																																																																																																																																																		
		50	(12.7)					8623-0050	70	(31.8)																																																																																																																																																																			
1¼	(31.8)	25	(6.4)	6 Ply Armored	2½	(66.7)	1¼	8625-0025	45	(20.4)	EP-400 through 1350, (when motor has 1¼ NPT retainer)																																																																																																																																																																		
		50	(12.7)					8625-0050	71	(32.2)																																																																																																																																																																			

## Tube ID Smart Chart

Find your tube Outer Diameter and Gauge or tube wall to determine tube Inner Diameter. For diameters not included here, use the charts on Pages 52, 53, and 54.

GA	0	1	2	3	4	5	6	7	8	9	10	11	12	13	14	15	16	17	18	19	20	21	22	23	24	
Wall:	.340	.300	.284	.259	.238	.220	.230	.180	.156	.148	.134	.120	.109	.095	.083	.072	.065	.058	.049	.042	.035	.032	.028	.025	.022	
OD (Inch)	----- Tube ID (Inner Diameter) In Decimal Inches -----																									
3/8									.045	.079	.107	.135	.175	.185	.209	.231	.245	.259	.277	.291	.305	.311	.319	.312	.331	
1/2				.024	.060	.094	.140	.170	.204	.232	.260	.282	.310	.334	.356	.370	.384	.402	.416	.430	.436	.444	.450	.456		
5/8	.025	.057	.107	.149	.185	.219	.265	.295	.329	.357	.385	.407	.435	.459	.481	.495	.509	.527	.541	.555	.561	.569	.575	.581		
3/4	.070	.150	.182	.232	.274	.310	.344	.390	.420	.454	.482	.510	.532	.560	.584	.606	.620	.634	.652	.666	.680	.686	.694	.700	.706	
7/8	.195	.275	.307	.357	.399	.435	.469	.515	.545	.579	.607	.635	.657	.685	.709	.731	.745	.759	.777	.791	.805	.811	.819	.825	.831	
1	.320	.400	.432	.482	.524	.560	.594	.640	.670	.704	.732	.760	.782	.810	.834	.854	.870	.884	.902	.916	.930	.936	.944	.950	.956	
1¼	.570	.650	.682	.732	.774	.810	.844	.890	.920	.954	.982	1.010	1.032	1.060	1.084	1.106	1.120	1.134	1.152	1.166	1.180					
1½	.820	.900	.932	.982	1.024	1.060	1.094	1.140	1.170	1.204	1.232	1.260	1.282	1.310	1.334	1.356	1.370	1.384	1.402	1.426	1.430					
2	1.320	1.400	1.432	1.482	1.524	1.560	1.594	1.640	1.670	1.704	1.732	1.760	1.782	1.810	1.834	1.856	1.870	1.884	1.902	1.916	1.930					
2½	1.820	1.900	1.932	1.982	2.024	2.060	2.094	2.140	2.170	2.204	2.232	2.260	2.282	2.310	2.334	2.356	2.370	2.384	2.402	2.416	2.430					
3	2.230	2.400	2.432	2.482	2.524	2.560	2.594	2.640	2.670	2.704	2.732	2.760	2.782	2.810	2.834	2.856	2.870	2.884	2.902	2.916	2.930					
4	3.320	3.400	3.432	3.482	3.524	3.560	3.594	3.640	3.670	3.704	3.732	3.760	3.782	3.810	3.834	3.856	3.870	3.884	3.902	3.916	3.930					

## Filter-Regulator-Lubricator



**Portable  
Filter-Lubricator**

It is very important to provide every air-operated tool with clean, lubricated, and properly pressurized air. Many job sites lack such conditions and the air provided may actually harm these air-operated tools. These popular assemblies, the **Filter-Regulator-Lubricator** and **Filter-Lubricator**, are offered as portable units.

Pipe Inches	Filter-Regulator-Lubricator		Filter-Lubricator		Air Line Filter 150 PSI (Max)		Pressure Regulator		Air Line Lubricator	
	Manifold Type	Portable Type	Manifold Type	Portable Type		Max. CFM		PSI		
Thread	Part No.	Part No.	Part No.	Part No.	Part No.	@100 PSI	Part No.	Range	Part No.	Capacity (Ozs.)
1/4	8905	8905-0250	8595	8595-0250	8910	79	8915	5-125	8894	10
3/8	8906	8906-0375	8596	8596-0375	8911	112	8916	5-125	3611	10
1/2	8907	8907-0500	8597	8597-0500	8912	138	8917	5-125	3612	10
3/4	8908	8908-0750	8598	8598-0750	8913	226	8918	10-125	3613	24
1	8909	8909-1000	8599	8599-1000	8914	331	8919	10-125	3627	24

## Air Line Lubricators

For use between supply hose and whip.



Pipe Inches	Air Line Lubricator	Capacity
Thread	Part No.	Ozs.
1/4	52035	.25
3/8	52399	.25
1/2	53360	2.6
3/4	53361	5.3
3/4	53362	8
1	53363	16

## Air Valves

For use between air motor and hose whip.

Pipe Inches	Air Valve	Major Diam.
Thread	Part No.	Inches
1/4	9439	.735
3/8	8774	.906
1/2	8654	1.375
3/4	8647	1.750
1	8669	2.000



## Hose Whips

These short lengths of hose are fitted with couplings and are used between the supply hose and the pneumatic tool. The hose is very flexible and lighter in weight than the operating or air supply hose. All hose used in Wilson hose whips is designed to withstand 250 pounds working pressure (psi).



Hose Size		Hose Whip Assembly with End Fittings		
ID Inches	OD Inches	Part No.	Length	Pipe Thread Inches
3/16	27/64	50001	8 Feet	1/8 x 1/4
1/4	15/32	50003	8 Feet	1/4 x 1/4
3/8	39/64	50371	8 Feet	1/4 x 3/8
3/8	39/64	50007	8 Feet	3/8 x 3/8
1/2	7/8	8973-0008	8 Feet	1/2 x 1/2

## WilsoLube

Rust-inhibiting Lubricant



WilsoLube	Part No.
Oil-Based (Gallon)	9047
Water-Soluble (Quart)	9047-0002
Water-Soluble (Gallon)	9047-0009

## EP Series Motors

### EP Series Air Motors

This family of air motors produces maximum horsepower in a given space, and their simplicity of design have earned them a reputation for reliability.

They develop maximum torque at the speeds at which **Wilson** cleaning heads are most efficient. The high torque developed by **EP Series Air Motors** is the result of their unique design that uses six light blade rotors and a double-chambered power seal cylinder.

Through an exclusive method of valving the compressed air, **EP Series Air Motors** are energy efficient, consuming less air than many other motors that are not as powerful. Lightweight blades reduce cylinder wear, so EP cylinders are very rarely replaced.



Smaller motor is pictured. Larger diameter motors are flanged construction for light weight.



To ensure a long and reliable motor life, use **WilsoLube** to lubricate your EP Series Air Motor (Page 43).

Selection Chart				----- Series "EP" Specification -----				
Nominal Tube ID Inches (mm)	Motor Model	Motor Assy.	Motor Body Diam.	Rotor Thread	Hose and Coupling	C.F.M. at 90 PSI	Weight Pounds (Kg)	
1 $\frac{1}{8}$ (34.9)	EP-137	4622-0131	1 $\frac{1}{8}$	7/16 x 14	3/8	32	1 $\frac{1}{4}$	(.6)
1 $\frac{1}{2}$ (38.1)	EP-150	3942-0143	1 $\frac{1}{8}$		1/2	45	1 $\frac{1}{8}$	(.8)
1 $\frac{1}{2}$ (44.5)	EP-175	2000-0156	1 $\frac{1}{8}$	9/16 x 12	1/2	47	2 $\frac{1}{2}$	(1.1)
2 (50.8)	EP-200	2012-0181	1 $\frac{1}{8}$	5/8 x 11	3/4	70	3 $\frac{1}{4}$	(1.5)
2 $\frac{1}{4}$ (57.2)	EP-225	7968-0212	2 $\frac{1}{8}$	3/4 x 10		73	5	(2.3)
2 $\frac{1}{2}$ (63.5)	EP-250	2044-0231	2 $\frac{5}{16}$		7/8 x 9	1	100	6 $\frac{3}{4}$
2 $\frac{3}{4}$ (69.9)	EP-275	2058-0262	2 $\frac{5}{16}$	1 x 14			1	108
3 (76.2)	EP-300	2072-0281	2 $\frac{1}{2}$		1 x 12	1		152
3 $\frac{1}{4}$ (82.6)	EP-325	2072-0306	3 $\frac{1}{8}$	1 x 12			1	164
3 $\frac{1}{2}$ (88.9)	EP-350	2091-0325	3 $\frac{1}{4}$		1 x 12	1		
3 $\frac{3}{4}$ (95.3)	EP-375	2091-0350	3 $\frac{1}{2}$	1 x 12			1	175
4 (101.6)	EP-400	2109-0375	3 $\frac{3}{4}$		1 x 12	1		
4 $\frac{1}{4}$ (108.0)	EP-425	2109-0400	4	1 x 12			1	175
4 $\frac{1}{2}$ (114.3)	EP-450	2109-0425	4 $\frac{1}{4}$		1 x 12	1		
4 $\frac{3}{4}$ (120.1)	EP-475	2109-0450	4 $\frac{1}{2}$	1 x 12			1	175
5 (127.0)	EP-500	2109-0475	4 $\frac{3}{4}$		1 x 12	1		
5 $\frac{1}{4}$ (133.4)	EP-525	3142-0500	5	1 x 12			1	225
5 $\frac{1}{2}$ (139.7)	EP-550	3142-0525	5 $\frac{1}{4}$		1 x 12	1		
5 $\frac{3}{4}$ (146.1)	EP-575	3142-0550	5 $\frac{1}{2}$	1 x 12			1	225
6 (152.4)	EP-600	3142-0575	5 $\frac{3}{4}$		1 x 12	1		
6 $\frac{1}{4}$ (158.8)	EP-625	3142-0600	6	1 x 12			1	225
6 $\frac{1}{2}$ (165.1)	EP-650	3142-0625	6 $\frac{1}{4}$		1 x 12	1		
6 $\frac{3}{4}$ (171.5)	EP-675	3142-0650	6 $\frac{1}{2}$	1 x 12			1	225
7 (177.8)	EP-700	3142-0675	6 $\frac{3}{4}$		1 x 12	1		
7 $\frac{1}{8}$ (187.3)	EP-737	7258-0712	7 $\frac{1}{8}$	1 x 12			1	225
7 $\frac{1}{4}$ (196.9)	EP-775	7258-0737	7 $\frac{1}{4}$		1 x 12	1		
8 $\frac{1}{2}$ (215.9)	EP-850	7258-0800	8	1 x 12			1	225
9 (228.6)	EP-900	7258-0850	8 $\frac{1}{2}$		1 x 12	1		
9 $\frac{1}{4}$ (247.7)	EP-975	7260-0925	9 $\frac{1}{4}$	1 x 12			1	225
10 (254.0)	EP-1000	7260-0950	9 $\frac{1}{2}$		1 x 12	1		
10 $\frac{1}{4}$ (260.4)	EP-1025	7260-0975	9 $\frac{3}{4}$	1 x 12			1	225
11 $\frac{1}{2}$ (292.1)	EP-1150	7260-1100	11		1 x 12	1		
11 $\frac{3}{4}$ (298.5)	EP-1175	7260-1125	11 $\frac{1}{4}$	1 x 12			1	225
12 (304.8)	EP-1200	7262-1150	11 $\frac{1}{2}$		1 x 12	1		
13 $\frac{1}{2}$ (342.9)	EP-1350	7262-1300	13	1 x 12			1	225





Body	Series "EP" Replacement Parts						
	Wear Plate	Cylinder	Rotor	Blades (Set of 6)	Rear Journal Assembly	Retainer Nut	Rotor Wrench
5818-0131	4628	4625	4623	4626	4627	4630	2031
5819-0143	3945	3943	3944	3946	3948	3950	3951
5820-0156	2008	2004	2003	2005	2007	2010	5760
5821-0181	2022	2018	2017	2019	2021	2024	2034
5822-0212	2039	2033	7969	2036	2038	2041	
5823-0231	2052	2048	2047	2049	8836	2054	2156
5825-0262	2070	2062	2061	2063	8837	2069	2157
5827-0281	2082	2079	2078	2080	8509	2087	2159
5827-0306							
5831-0325	2100	2097	2096	2098	8839	2105	2149
5831-0350							
5835-0375	2120	2126	2117	2118	8841	2125	
5835-0400							
5835-0425							
5835-0450							
5835-0475	3149	3145	3143	3146	8842	3151	2630
5837-0500							
5837-0525							
5837-0550							
5837-0575							
5837-0600							
5837-0625							
5837-0650							
5837-0675							
7264-0712							
7264-0737							
7264-0800							
7264-0850							
7265-0925	3149	3145	3143	3146	8842	3151	
7265-0950							
7265-0975							
7265-1100							
7265-1125	3149	3145	3143	3146	8842	3151	
7266-1150							
7266-1300							

## MS Series Motors

Specifically designed to drive expanding brushes, expanding scrapers, and small cutter heads, these high speed motors will clean straight and curved tubes to a high polish. And, their steel rotor blades ensure durability and reliability.



----- Series "MS" Selection Chart -----			----- Series "MS" Specifications -----					
Nominal Tube ID Inches (mm)	Motor Model	Motor Assy.	Motor Body Dia	Rotor Thread	Hose & Coupling	C.F.M. at 90 PSI	Weight lbs. (Kg)	
1/2 (12.7)	MS-0	2996	15/32	10-28	*	9	1/8 (.06)	
5/8 (15.9)	MS-1	3002	9/16	10-28	*	10	3/16 (.09)	
3/4 (19.1)	MS-1A	3050	11/16	12-24	1/4	12	3/16 (.09)	
7/8 (22.2)	MS-3	8984	49/64	5/16 x 18	1/4	13	3/16 (.09)	
1 (25.4)	MS-4	8987	7/8	5/16 x 18	3/8	18	1/4 (.11)	
1 1/8 (28.6)	MS-5	8989	31/32	3/8 x 16	3/8	25	7/16 (.20)	
1 1/2 (31.0)	MS-6	8992	1 3/32	7/16 x 14	3/8	30	13/16 (.37)	
1 5/8 (35.6)	MS-8	8997	1 1/4	7/16 x 14	3/8	35	1 1/8 (.54)	
1 3/4 (44.5)	MS-10	8999	1 5/8	7/16 x 14	3/8	40	1 1/2 (.77)	

\* 3/16 Motor End only. Manifold End is 1/4.

## C Series Air Motors

This air motor is often used with a **Type C Flexible Holder** (Page 33) to clean curved tubes in boilers, heat exchangers, superheaters, economizers, and other curved tube structures.



----- Series "C" Selection Chart -----			----- Series "C" Specifications -----					
Nominal Tube ID Inches (mm)	Motor Model	Motor Assy.	Motor Body Dia	Rotor Thread	Hose & Coupling	C.F.M. at 90 PSI	Weight Pounds (Kg)	
25/32 (19.8)	C-2	2745	11/16	12-24	1/4	12	1/4 (.11)	
7/8 (22.2)	C-3	2755	49/64	1/4 x 20	1/4	13	5/16 (.14)	
1 (25.4)	C-4	2765	7/8	5/16 x 18	1/4	18	7/16 (.20)	
1 1/8 (28.6)	C-5	2773	31/32	5/16 x 18	3/8	25	9/16 (.26)	
1 1/2 (31.0)	C-6	2783	1 3/32	3/8 x 16	3/8	30	5/8 (.28)	
1 1/2 (38.1)	C-8	2793	1 7/16	7/16 x 14	3/8	35	1 1/8 (.48)	
1 3/4 (44.5)	C-10	2799	1 11/32	7/16 x 14	3/8	40	1 1/8 (.51)	
2 (50.8)	C-12	8588	1 3/2	9/16 x 12	1/2	50	1 1/2 (.68)	

## ECT Series Air Motors

Designed to clean tubes of 2 1/8-inch Inner Diameter and larger, the ECT Series Air Motors pick up where the C Series Air Motors end. The short design of the ECT Series Air Motors make them especially maneuverable when cleaning curved tubes, water tube boilers, and other large diameter tubular vessels.



----- Series "ECT" Selection Chart -----			----- Series "ECT" Specifications -----					
Nominal Tube ID Inches (mm)	Motor Model	Motor Assy.	Motor Body Dia	Rotor Thread	Hose & Coupling	C.F.M. at 90 PSI	Weight Pounds (Kg)	
2 1/8 (54.0)	ECT-212	4090-0175	1 3/4	5/8 x 11	1/2	35	2 1/8 (1.2)	
2 1/8 (60.3)	ECT-237	4090-0200	2	5/8 x 11	1/2	35	3 1/2 (1.6)	
2 1/8 (66.7)	ECT-262	4925-0225	2 1/4	3/4 x 10	3/4	55	4 1/2 (1.9)	
2 1/8 (73.0)	ECT-287	4099-0256	2 5/8	3/4 x 10	3/4	65	5 1/2 (2.6)	
3 1/8 (79.4)	ECT-312	4035-0275	2 3/4	7/8 x 9	1	85	8 1/8 (4.0)	
3 1/8 (92.1)	ECT-362	4035-0318	3 1/8	7/8 x 9	1	85	9 3/4 (4.4)	
4 (101.6)	ECT-400	4541-0325	3 3/4	1 1/8 x 12	1	110	10 (4.5)	
4 1/2 (114.3)	ECT-450	4541-0375	3 3/4	1 1/8 x 12	1	110	11 1/4 (5.1)	
5 (127.0)	ECT-500	4315-0425	4 1/4	1 1/8 x 12	1	125	16 1/8 (7.7)	
5 1/2 (139.7)	ECT-550	4315-0450	4 1/2	1 1/8 x 12	1	125	17 1/2 (7.9)	
6 (152.4)	ECT-600	4315-0500	5	1 1/8 x 12	1	125	18 1/2 (8.5)	
6 1/2 (165.1)	ECT-650	4315-0550	5 1/2	1 1/8 x 12	1	125	20 (9.1)	



Series "MS" Replacement Parts					
Body	Rotor	Blades (Set of 4)	Bearing	Retainer Nut	Rotor Wrench
2998	2997	3001	3000	2999	2057
3004	3003	3007	3006	3005	
3052	2747	2749	2748	3053	2001
8986	8985	2759	2758	6238	2016
8988	2765	2767	2766	9009	
8991	8990	2777	2776	6239	2028
8994	8993	2787	2786	6240	2031
8998	2795	2797	2796	6241	
9000	2801	2803	2802	9024	



Series "C" Replacement Parts					
Body	Rotor	Blades (Set of 4)	Bearing	Hose Piece Assembly	Rotor Wrench
2746	2747	2749	2748	4327	2001
2756	2757	2759	2758	4328	2013
2764	2765	2767	2766	4329	2016
2774	2775	2777	2776	4330	
2784	2785	2787	2786	4331	2028
2794	2795	2797	2796	4332	2031
2800	2801	2803	2802	4333	
7209	2808	2812	2810	8589	2014



Series "ECT" Replacement Parts							
Body	Cylinder	Wear Plate	Rotor	Blade (Set of 6)	Rear Jour. Assy.	Hose Pc. Assy.	Rotor Wrench
5841-0175	4092	4093	4091	4095	4094	9230	2138
5841-0200	4092	4093	4091	4095	4094	9230	
5842-0225	4038	4041	4037	4034	8850	9231	2375
5845-0256	4101	4102	4100	4105	8504	9232	
5848-0275	4048	4051	4047	4036	8851	9233	2034
5848-0318	4048	4051	4047	4036	8851	9233	
5851-0325	4544	2100	4543	4545	8852	9234	2149
5851-0375	4544	2100	4543	4545	8852	9234	
5853-0425	4318	3780	4316	4339	8853	4341	
5853-0450	4318	3780	4316	4339	8853	4341	
5853-0500	4318	3780	4316	4339	8853	4341	2149
5853-0550	4318	3780	4316	4339	8853	4341	

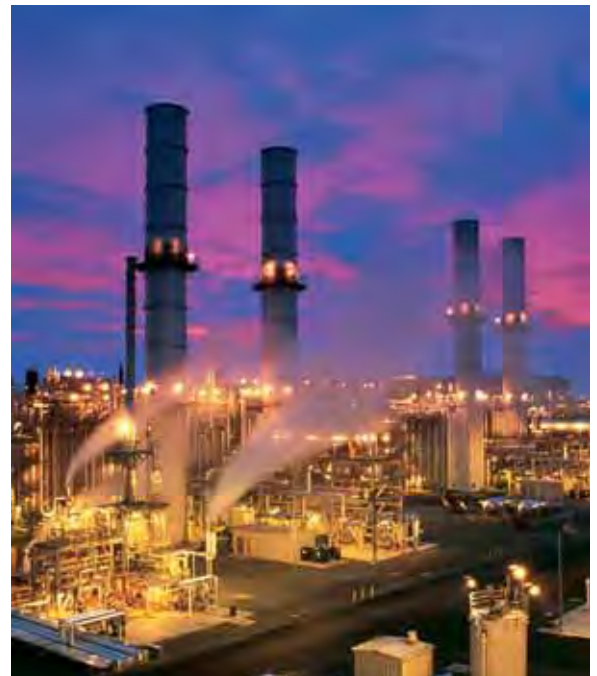



## Blo Gun Motor

Key No.	Description	Part No.
	<b>Blo-Gun Assembly</b>	
	.266 - 0.813 inches (6.7 - 20.6mm) Tube ID	8044
	.563 - 1.000 inches (14.3 - 25.4mm) Tube ID	8045
	.813 - 1.250 inches (20.6 - 31.8mm) Tube ID	8586
	<b>Nozzle</b>	
	.266 - 0.813 inches (6.7 - 20.6mm) Tube ID	8054
1	.563 - 1.000 inches (14.3 - 25.4mm) Tube ID	8089
	.813 - 1.250 inches (20.6 - 31.8mm) Tube ID	8416
2	<b>Thrust Tube</b>	8052
3	<b>Pin</b> (2 Req'd)	8049
4	<b>Shield</b>	8086
5	<b>Retainer Nut</b>	8051
6	<b>Seal</b> (3 Req'd)	7587
7	<b>Liner</b>	8048
8	<b>Spring</b>	8088
9	<b>Handle</b>	8047
10	<b>O-Ring</b>	1001-0012

Weight  
Lbs. (Kg)  
2 (.9)

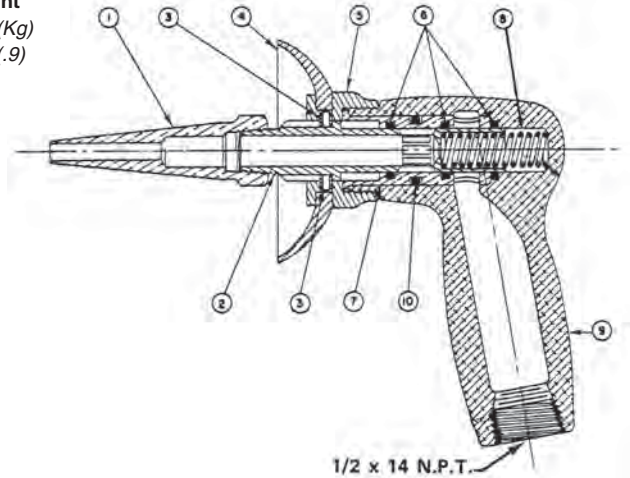

## PG Motor



Key No.	Description	Part No.
1	Rotor	7009
2	Body Sub-Assembly	8408
	Front Bushing (part of)	7015
	O-Ring (part of)	7587
3	Oil Cup (part of 8408)	7578
4	Scavenger Seal (2 req'd.)	8523
	O-Ring (part of)	8525
5	Seal Spring	7014
6	Seal Spring Washer (2 req'd)	6999
7	Seat Gasket	7011
8	Seal Seat	7010
9	Wear Plate	4093
10	Cylinder	4092-1
11	Rotor Blades Set (of 6)	4095
12	Rear Journal	4094
13	Retainer Nut	7008
14	Cap	7007
15	Valve Assembly	7018
16	Trigger	7016
17	Trigger Screw	7017

Weight  
Lbs. (Kg)  
3 (1.4)

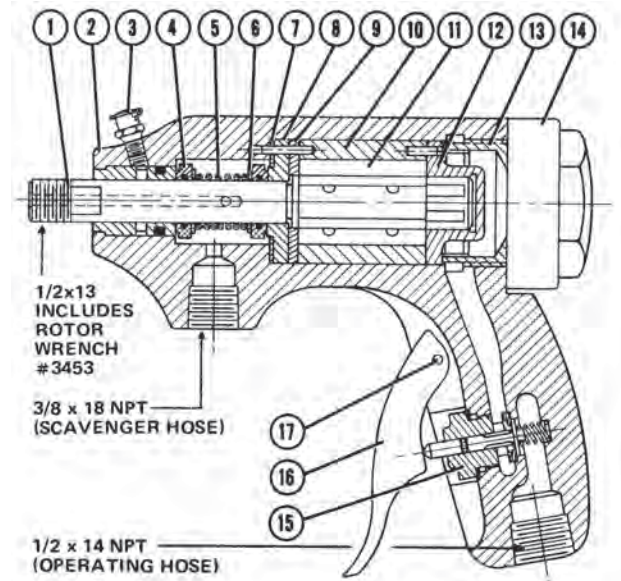

# PGX-2 Motor

Key No.	Description	Part No.
1	Rotor	8739
2	Body Sub-Assembly	9356
	Front Bushing (part of)	9289
3	Thrust Bearing	9293
4	Thrust Bushing	9290
5	Wear Plate	9292
6	Cylinder	9357
7	Rotor Blade Set (of 6)	4105
8	Rear Bushing	4104
9	Rear Journal	4103
10	Journal Gasket	7942
11	Seat Seal	7943
12	Seal Cap	7945
13	O-Ring	7944
14	Scavenger Seal	8523
	O-Ring (part of)	8525
15	Seal Washer	6999
16	Spring	7014
17	Seal Stem	8738
18	Valve Assembly	8527
19	Valve Spring	7939
20	Valve Bushing	7941
	O-Ring (part of)	7830
21	Trigger Screw	7946
22	Trigger	7947
23	Handle Sub-Assembly	7932
24	Muffler Assembly	9295
	Screen (part of)	9358
	O-Ring (part of)	9300
	Spirolox (part of)	9301

**Weight**  
Lbs. (Kg)  
6 $\frac{3}{4}$  (3.1)

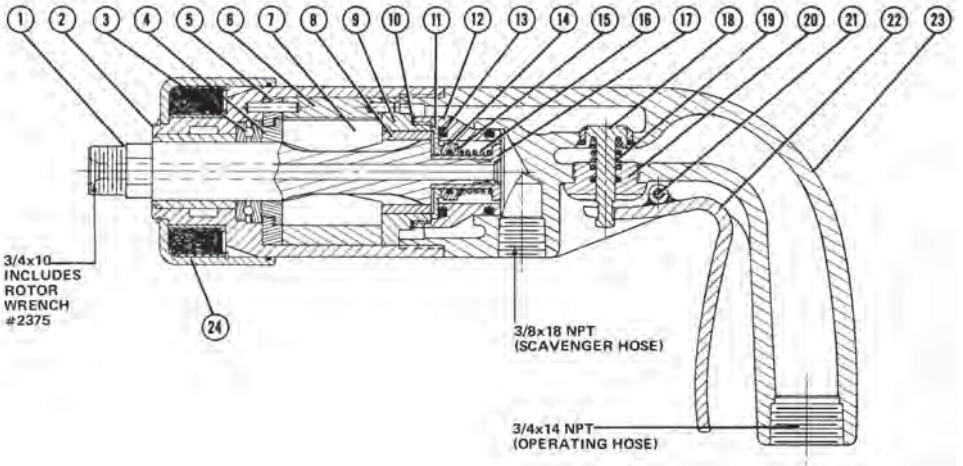

Key No.	Description	Part No.
1	Rotor Assembly	9182
2	Housing Assembly	9274
	Dowel (part of)	9268
	Bushing (part of)	20597
3	Set Screw	41334
4	Thrust Ball Bearing	9270
5	Wear Plate	9272
6	Thrust Bushing	9271
7	Cylinder	9273
8	Rotor Blade Set (of 6)	2080
9	Rear Journal	7802
10	O-Ring (2 req'd)	7602
11	Seat Gasket	7605
12	Seal Seat	7604
13	Scavenger Seal	7789
	O-Ring (Part of)	7625
14	Spring Washer	7608
15	Seal Spring	7624
16	Seal Ring Fork	7626
17	Rear Plug	7593
18	Quad Ring	28102
19	Dead Handle	7597
20	Eye Bolt	7661
21	Spring (2 req'd)	7611
22	Cap Screw	7616
23	Grip Lock Pin	7614
24	Grip Lock	7622
25	Handle Grip Bearing	7613
26	Valve Spring	7615
27	Valve Assembly	8531
28	Cam Follower Pin	7623
29	Cam Follower Roll (2 req'd)	7619
30	Handle Grip	7621
31	Handle Grip Spring	7620
32	Live Handle Assembly	7598
	Valve Stem Seal (part of)	6685

# TP-302 Motor

**Weight**  
Lbs. (Kg)  
15 $\frac{1}{4}$  (7.1)

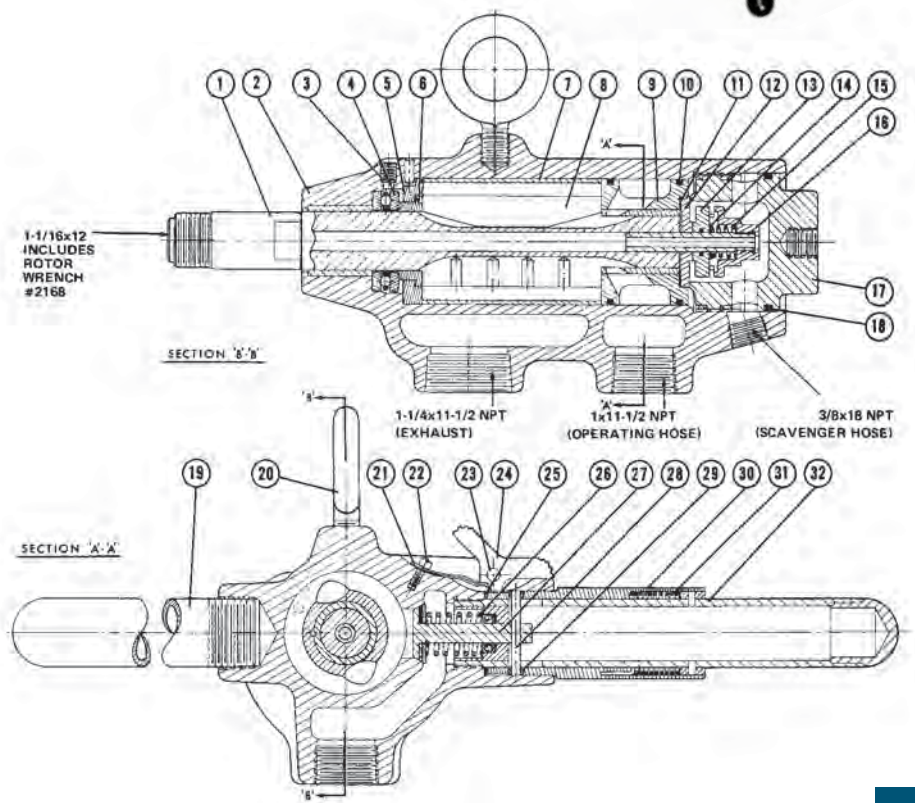



## Flo-Breaker - Safely Cuts Off Excess Air Flow

The powerful force of compressed air escaping from a broken air hose causes the hose to whip, creating a dangerous hazard to personnel and equipment. The Flo-Breaker safely cuts off excess air flow. Hose will not whip.

### Features

- Non-Clogging
  - Automatic Reset
  - No Adjustment Necessary
  - Stainless Steel Springs (unaffected by temperature)
  - Low Pressure Drop-means high productivity
- New York State BSA approved-patent no. 3,561,471

Excerpt from the Department of Labor Occupational Safety and Health Administration regulation 29 CFR part 1926 for Construction.

§ 1926.302 Power-Operated hand tools:

(7) All hoses exceeding 1/2-inch inside diameter shall have a safety device at the source of supply or branch line to reduce pressure in case of hose failure.

### Standard Model – Inserts Between Male Pipe Threads



Pipe Size Inches	Outline Dimensions			Hex Inches
	A Inches	B Inches	C Inches	
3/8	4¼	1¼	1⅙	1
1/2	3½	1¼	1⅙	1
3/4	3⅞	1½	1⅞	1½
1	4½	2	2½	1¾
1¼	5	3	2¾	2½
1½	5¼	3½	2¾	2¾
2	6¼	4¼	3½	3½

Pipe Size Inches	Shut-Off Flow Rate @90 psi SCFM	Standard Model Part No.	Weight Pounds	Shut-Off Flow Rates at Selected Air Pressures				
				60 psi SCFM	90 psi SCFM	110 psi SCFM	130 psi SCFM	150 psi SCFM
NPT								
3/8	45	1050-1040	1/4	38	45	49	52	56
1/2	65	1051-1030		55	65	71	76	82
	80	1051-1040	68	80	87	94	100	
3/4	115	1052-1020	3/8	97	115	125	135	144
	135	1052-1030		114	135	147	159	169
	180	1052-1040		152	180	196	212	226
1	250	1053-1020	3/4	211	250	273	294	314
1¼	450	1054-1020	5¼	380	450	491	529	564
1½	650	1055-1020	7	549	650	709	764	815
2	1200	1056-1200	13	845	1050	1120	1190	1250

### 3-Inch Pipe Size Also Available upon Request

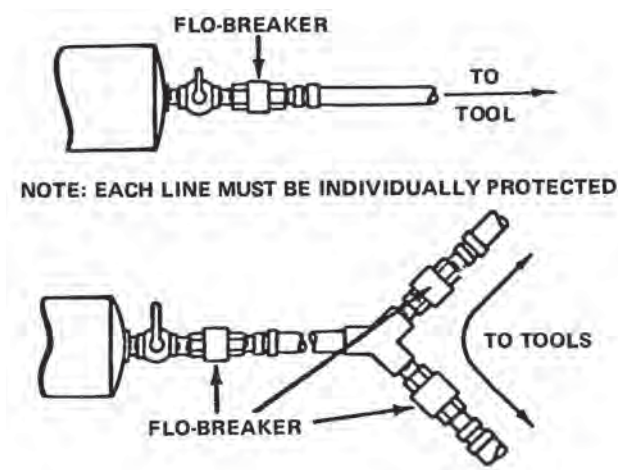

### Shut-off Flow Rate

Be certain to select a **Flo-Breaker** with a safe shut-off flow rating (i.e., a sufficiently low rating). This rating may be calculated from installation data or determined by a test which simulates hose rupture.

Any test should be in the actual installation and simulated hose failure should be at the farthest protected downstream location from the **Flo-Breaker**. The simulated hose-rupture must trip the **Flo-Breaker**, safely shutting off air flow. If it does not, the test should be repeated with a **Flo-Breaker** of lower rating.

Precaution should be taken in the above tests to protect personnel and equipment against possible hose whip in the event that the **Flo-Breaker** rating is too high for the installation.



## Gas Line Renewal Kit



### Applications

- Cleaning 3/4 – 2-Inch Pipe (Schedule 40) Gas Lines prior to Installation of Replacement Tubing
- Cone Cutter and Cutter Wheel Create Powerful Chipping Action that Removes Any Deposits in the Line
- Optional **Cherry Burr (Part No. 9838)** Provides Extra Cleaning Action for 3/4-Inch Pipe
- Kit Includes Everything Needed for Thorough Gas Line Tube Cleaning, including Tool Box (Part No. 6404-0001)



Pipe Size		Kit	Air Motor	Motor Diam		CFM (@90psi)	Model A Cutter Head	Universal Joint	Cone Cutters (3)	Cutter Wheels (24)	Rotor Wrench
Inches	ID			Inches	(mm)						
3/4	.824	9710	3050	11/16	(17.5)	12	62598	3062	19	34	2001
1	1.049	9711	8987	7/8	(22.2)	18	62599	2242	22	83	2016
1 1/4	1.380	9712	8992	1 1/2	(27.8)	30	62600	2212	41-0437	74-0437	2031
1 1/2	1.610	9713	3942-0143	1 7/8	(36.5)	45	62601		27	75-0562	3951
2	2.067	9714	2000-0156	1 3/4	(39.7)	47	62720	2140	14	72-0562	5760

## Aerco Water Heater Cleaning System



### Applications

- Removing Soot and Scale from Fire Tubes in Aerco Water Heaters
- Flexible Shaft & Casing and Expanding Brush Maneuver around Curves
- Special Teflon® Shaft Can Be Run Dry without Damage to Shaft & Casing Assembly
- Kit Includes Drive Unit, Teflon® Shaft & Casing, Stainless Steel Expanding Brush, and Stainless Steel Refill Set

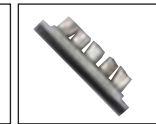
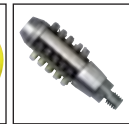
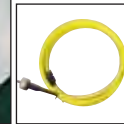

Aerco Tube ID		Kit	Drive Unit	Shaft & Casing	Expanding Brush	Brush Refill Set
Inches	(mm)					
.621 - .652	(15.7 - 16.6)	9611	9600	9722-6012	9900-0006	7003-0006

## Catalyst Cleaning System

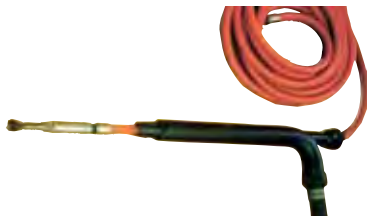

### Applications

- Removing Spent Catalyst from 1 1/8 – 5-Inch (30.2 - 127.0mm) Tubes in Reactor Units
- Powerful Air Motor is Lightweight and Maneuverable, Specially Designed for Overhead Cleaning
- Special Nozzle Attachment Directs Catalyst into Collection Container
- Kit Includes Air Motor, Cleaning Head with Adapter, Elbow Unit and Conveyor Tube Assembly, Air Hose, Rotor Blade and Wrench, Dust Seal Cap and Dust Seal Adapter, and Washer and Seal
- Standard Kit Cleans 2-Inch (50.8mm) Outer Diameter Tubes
- For Other Sizes, Specify Tube Inner Diameter, and We Will Configure Kit for that Application

Reactor Tube ID		Kit	Air Motor	Type K Cutter Bit	F-F Adapter	Elbow Unit Assembly	Conveyor Tube Assembly	50-Foot Air Hose	Rotor Blade	Wrench
Inches	(mm)									
1.812 - 1.936	(46.0 - 49.2)	62716	62546	7706	9011	62716-0001	62716-0002	62716-0004	2005	2014



INCHES

BOILER AND CONDENSER TUBE SIZES

TUBE		20	19	18	17	16	15	14	13	12	11	10	9	8	7	6	5	4	3	2	1	0
O.D.	I.D.	.035	.042	.049	.058	.065	.072	.083	.095	.109	.120	.134	.148	.165	.180	.203	.220	.238	.259	.284	.300	.340
1/2	Min.	.422	.408	.392	.373	.357	.342	.318	.291	.260	.236											
	Nom.	.430	.416	.402	.384	.370	.356	.334	.310	.282	.260											
5/8	Min.	.547	.533	.517	.498	.482	.467	.443	.417	.385	.361	.330	.299	.262	.229							
	Nom.	.555	.541	.527	.509	.495	.481	.459	.435	.407	.385	.357	.329	.295	.265							
3/4	Min.	.672	.658	.642	.623	.607	.592	.568	.542	.510	.486	.455	.424	.387	.354	.303	.266	.226	.180			
	Nom.	.680	.666	.652	.634	.620	.606	.584	.560	.532	.510	.482	.454	.420	.390	.344	.310	.274	.232			
7/8	Min.	.797	.783	.767	.747	.732	.717	.693	.666	.636	.611	.580	.549	.512	.479	.428	.391	.351	.305			
	Nom.	.805	.791	.777	.759	.745	.731	.709	.685	.657	.635	.607	.579	.545	.515	.469	.435	.399	.357			
1	Min.	.922	.908	.892	.873	.857	.842	.818	.791	.761	.736	.706	.675	.637	.604	.553	.516	.476	.430	.375	.340	.252
	Nom.	.930	.916	.902	.884	.870	.856	.834	.810	.782	.760	.732	.704	.670	.640	.594	.560	.524	.482	.432	.400	.320
1-1/8	Min.	1.047	1.033	1.017	.997	.982	.967	.943	.916	.886	.861	.831	.800	.762	.729	.678	.641	.601	.555	.500	.465	.377
	Nom.	1.055	1.041	1.027	1.009	.995	.981	.959	.935	.907	.885	.857	.829	.795	.765	.719	.685	.649	.607	.557	.525	.445
1-1/4	Min.	1.172	1.158	1.142	1.122	1.107	1.092	1.068	1.041	1.011	.986	.956	.925	.887	.854	.803	.766	.726	.680	.625	.590	.502
	Nom.	1.180	1.166	1.152	1.134	1.120	1.106	1.084	1.060	1.032	1.010	.982	.954	.920	.890	.844	.810	.774	.732	.682	.650	.570
1-3/8	Min.	1.297	1.283	1.267	1.247	1.232	1.217	1.192	1.166	1.136	1.111	1.081	1.049	1.012	.979	.928	.891	.851	.805	.750	.715	.627
	Nom.	1.305	1.291	1.277	1.259	1.245	1.231	1.209	1.185	1.157	1.135	1.107	1.079	1.045	1.015	.969	.935	.899	.857	.807	.775	.695
1-1/2	Min.	1.422	1.408	1.392	1.372	1.357	1.342	1.318	1.291	1.260	1.236	1.205	1.174	1.137	1.104	1.053	1.016	.976	.930	.875	.840	.752
	Nom.	1.430	1.426	1.402	1.384	1.370	1.356	1.334	1.310	1.282	1.260	1.232	1.204	1.170	1.140	1.094	1.060	1.024	.982	.932	.900	.820
1-3/4	Min.	1.672	1.658	1.642	1.622	1.607	1.592	1.568	1.541	1.510	1.486	1.455	1.424	1.387	1.354	1.303	1.266	1.226	1.180	1.125	1.090	1.002
	Nom.	1.680	1.666	1.652	1.634	1.620	1.606	1.584	1.560	1.532	1.510	1.482	1.454	1.420	1.390	1.344	1.310	1.274	1.232	1.182	1.150	1.070
2	Min.	1.922	1.908	1.892	1.872	1.857	1.842	1.817	1.791	1.760	1.736	1.705	1.674	1.637	1.604	1.553	1.516	1.476	1.430	1.375	1.340	1.252
	Nom.	1.930	1.916	1.902	1.884	1.870	1.856	1.834	1.810	1.782	1.760	1.732	1.704	1.670	1.640	1.594	1.560	1.524	1.482	1.432	1.400	1.320
2-1/4	Min.	2.172	2.158	2.142	2.122	2.107	2.092	2.067	2.041	2.010	1.986	1.955	1.924	1.887	1.854	1.803	1.766	1.726	1.680	1.625	1.590	1.502
	Nom.	2.180	2.166	2.152	2.134	2.120	2.106	2.084	2.060	2.032	2.010	1.982	1.954	1.920	1.890	1.844	1.810	1.774	1.732	1.682	1.650	1.570
2-1/2	Min.	2.422	2.408	2.392	2.372	2.357	2.342	2.317	2.291	2.260	2.236	2.205	2.174	2.137	2.104	2.053	2.016	1.976	1.930	1.875	1.840	1.752
	Nom.	2.430	2.416	2.402	2.384	2.370	2.356	2.334	2.310	2.282	2.260	2.232	2.204	2.170	2.140	2.094	2.060	2.024	1.982	1.932	1.900	1.820
2-3/4	Min.	2.672	2.658	2.642	2.622	2.607	2.592	2.567	2.541	2.510	2.486	2.455	2.424	2.387	2.354	2.303	2.266	2.226	2.180	2.125	2.090	2.002
	Nom.	2.680	2.666	2.652	2.634	2.620	2.606	2.584	2.560	2.532	2.510	2.482	2.454	2.420	2.390	2.344	2.310	2.274	2.232	2.182	2.150	2.070
3	Min.	2.922	2.908	2.892	2.872	2.857	2.842	2.817	2.791	2.760	2.736	2.705	2.674	2.637	2.604	2.553	2.516	2.476	2.430	2.375	2.340	2.252
	Nom.	2.930	2.916	2.902	2.884	2.870	2.856	2.834	2.810	2.782	2.760	2.732	2.704	2.670	2.640	2.594	2.560	2.524	2.482	2.432	2.400	2.320
3-1/4	Min.	3.172	3.158	3.142	3.122	3.107	3.092	3.067	3.041	3.010	2.986	2.955	2.924	2.887	2.854	2.803	2.766	2.726	2.680	2.625	2.590	2.502
	Nom.	3.180	3.166	3.152	3.134	3.120	3.106	3.084	3.060	3.032	3.010	2.982	2.954	2.920	2.890	2.844	2.810	2.774	2.732	2.682	2.650	2.570
3-1/2	Min.	3.422	3.408	3.392	3.372	3.357	3.342	3.317	3.291	3.260	3.236	3.205	3.174	3.137	3.104	3.053	3.016	2.976	2.930	2.875	2.840	2.752
	Nom.	3.430	3.416	3.402	3.384	3.370	3.356	3.334	3.310	3.282	3.260	3.232	3.204	3.170	3.140	3.094	3.060	3.024	2.982	2.932	2.900	2.820
3-3/4	Min.	3.672	3.658	3.642	3.622	3.607	3.592	3.567	3.541	3.510	3.486	3.455	3.424	3.387	3.354	3.303	3.266	3.226	3.180	3.125	3.090	3.002
	Nom.	3.680	3.666	3.652	3.634	3.620	3.606	3.584	3.560	3.532	3.510	3.482	3.454	3.420	3.390	3.344	3.310	3.274	3.232	3.182	3.150	3.070
4	Min.	3.922	3.908	3.892	3.872	3.857	3.842	3.817	3.791	3.760	3.736	3.705	3.674	3.637	3.604	3.553	3.516	3.476	3.430	3.375	3.340	3.252
	Nom.	3.930	3.916	3.902	3.884	3.870	3.856	3.834	3.810	3.782	3.760	3.732	3.704	3.670	3.640	3.594	3.560	3.524	3.482	3.432	3.400	3.320
4-1/2	Min.	4.422	4.408	4.392	4.372	4.357	4.342	4.317	4.291	4.260	4.236	4.205	4.174	4.137	4.104	4.053	4.016	3.976	3.930	3.875	3.840	3.752
	Nom.	4.430	4.416	4.402	4.384	4.370	4.356	4.334	4.310	4.282	4.260	4.232	4.204	4.170	4.140	4.094	4.060	4.024	3.982	3.932	3.900	3.820
5	Min.	4.922	4.908	4.892	4.872	4.857	4.842	4.817	4.791	4.760	4.736	4.705	4.674	4.637	4.604	4.553	4.516	4.476	4.430	4.375	4.340	4.252
	Nom.	4.930	4.916	4.902	4.884	4.870	4.856	4.834	4.810	4.782	4.760	4.732	4.704	4.670	4.640	4.594	4.560	4.524	4.482	4.432	4.400	4.320

ADDITIONAL BIRMINGHAM WIRE GAGES

NUMBER	36	35	34	33	32	31	30	29	28	27	26	25	24	23	22	21	00	000	0000	00000
	.004	.005	.007	.008	.009	.010	.012	.013	.014	.016	.018	.020	.022	.025	.028	.032	.380	.425	.454	.500



## MILLIMETERS

## BOILER AND CONDENSER TUBE SIZES

THICKNESS OF WALL IN BIRMINGHAM WIRE GAGE AND IN MILLIMETERS																								
TUBE		20	19	18	17	16	15	14	13	12	11	10	9	8	7	6	5	4	3	2	1	0		
O.D. (IN.)	O.D. (MM)	I.D.	.9	1.1	1.2	1.5	1.7	1.8	2.1	2.4	2.8	3.0	3.4	3.8	4.2	4.6	5.2	5.6	6.0	6.6	7.2	7.6	8.6	
1/2	12.7	Min.	10.7	10.4	10.0	9.5	9.1	8.7	8.1	7.4	6.6	6.0												
		Nom.	10.9	10.6	10.2	9.8	9.4	9.0	8.5	7.9	7.2	6.6												
5/8	15.9	Min.	13.9	13.5	13.1	12.6	12.2	11.9	11.3	10.6	9.8	9.2	8.4	7.6	6.7	5.8								
		Nom.	14.1	13.7	13.4	12.9	12.6	12.2	11.7	11.0	10.3	9.8	9.1	8.4	7.5	6.7								
3/4	19.1	Min.	17.1	16.7	16.3	15.8	15.4	15.0	14.4	13.8	13.0	12.3	11.6	10.8	9.8	9.0	7.7	6.8	5.7	4.6				
		Nom.	17.3	16.9	16.6	16.1	15.7	15.4	14.8	14.2	13.5	13.0	12.2	11.5	10.7	9.9	8.7	7.9	7.0	5.9				
7/8	22.2	Min.	20.2	19.9	19.5	19.0	18.6	18.2	17.6	16.9	16.2	15.5	14.7	13.9	13.0	12.2	10.9	9.9	8.9	7.7				
		Nom.	20.4	20.1	19.7	19.3	18.9	18.6	18.0	17.4	16.7	16.1	15.4	14.7	13.8	13.1	11.9	11.0	10.1	9.1				
1	25.4	Min.	23.4	23.1	22.7	22.2	21.8	21.4	20.8	20.1	19.3	18.7	17.9	17.1	16.2	15.3	14.0	13.1	12.1	10.9	9.5	8.6	6.4	
		Nom.	23.6	23.3	22.9	22.5	22.1	21.7	21.2	20.6	19.9	19.3	18.6	17.9	17.0	16.3	15.1	14.2	13.3	12.2	11.0	10.2	8.1	
1-1/8	28.6	Min.	26.6	26.2	25.8	25.3	24.9	24.6	24.0	23.3	22.5	21.9	21.1	20.3	19.4	18.5	17.2	16.3	15.3	14.1	12.7	11.8	9.6	
		Nom.	26.8	26.4	26.1	25.6	25.3	24.9	24.4	23.7	23.0	22.5	21.8	21.1	20.2	19.4	18.3	17.4	16.5	15.4	14.1	13.3	11.3	
1-1/4	31.8	Min.	29.8	29.4	29.0	28.5	28.1	27.7	27.1	26.4	25.7	25.0	24.3	23.5	22.5	21.7	20.4	19.5	18.4	17.3	15.9	15.0	12.8	
		Nom.	30.0	29.6	29.3	28.8	28.4	28.1	27.5	26.9	26.2	25.7	24.9	24.2	23.4	22.6	21.4	20.6	19.7	18.6	17.3	16.5	14.5	
1-3/8	34.9	Min.	32.9	32.6	32.2	31.7	31.3	30.9	30.3	29.6	28.9	28.2	27.5	26.6	25.7	24.9	23.6	22.6	21.6	20.4	19.1	18.2	15.9	
		Nom.	33.1	32.8	32.4	32.0	31.6	31.3	30.7	30.1	29.4	28.8	28.1	27.4	26.5	25.8	24.6	23.7	22.8	21.8	20.5	19.7	17.7	
1-1/2	38.1	Min.	36.1	35.8	35.4	34.8	34.5	34.1	33.5	32.8	32.0	31.4	30.6	29.8	28.9	28.0	26.7	25.8	24.8	23.6	22.2	21.3	19.1	
		Nom.	36.3	36.2	35.6	35.2	34.8	34.4	33.9	33.3	32.6	32.0	31.3	30.6	29.7	29.0	27.8	26.9	26.0	24.9	23.7	22.9	20.8	
1-3/4	44.5	Min.	42.5	42.1	41.7	41.2	40.8	40.4	39.8	39.1	38.4	37.7	37.0	36.2	35.2	34.4	33.1	32.2	31.1	30.0	28.6	27.7	25.5	
		Nom.	42.7	42.3	42.0	41.5	41.1	40.8	40.2	39.6	38.9	38.4	37.6	36.9	36.1	35.3	34.1	33.3	32.4	31.3	30.0	29.2	27.2	
2	50.8	Min.	48.8	48.5	48.1	47.5	47.2	46.8	46.2	45.5	44.7	44.1	43.3	42.5	41.6	40.7	39.4	38.5	37.5	36.3	34.9	34.0	31.8	
		Nom.	49.0	48.7	48.3	47.9	47.5	47.1	46.6	46.0	45.3	44.7	44.0	43.3	42.4	41.7	40.5	39.6	38.7	37.6	36.4	35.6	33.5	
2-1/4	57.2	Min.	55.2	54.8	54.4	53.9	53.5	53.1	52.5	51.8	51.1	50.4	49.7	48.9	47.9	47.1	45.8	44.9	43.8	42.7	41.3	40.4	38.2	
		Nom.	55.4	55.0	54.7	54.2	53.8	53.5	52.9	52.3	51.6	51.1	50.3	49.6	48.8	48.0	46.8	46.0	45.1	44.0	42.7	41.9	39.9	
2-1/2	63.5	Min.	61.5	61.2	60.8	60.2	59.9	59.5	58.9	58.2	57.4	56.8	56.0	55.2	54.3	53.4	52.1	51.2	50.2	49.0	47.6	46.7	44.5	
		Nom.	61.7	61.4	61.0	60.6	60.2	59.8	59.3	58.7	58.0	57.4	56.7	56.0	55.1	54.4	53.2	52.3	51.4	50.3	49.1	48.3	46.2	
2-3/4	69.9	Min.	67.9	67.5	67.1	66.6	66.2	65.8	65.2	64.5	63.8	63.1	62.4	61.6	60.6	59.8	58.5	57.6	56.5	55.4	54.0	53.1	50.9	
		Nom.	68.1	67.7	67.4	66.9	66.5	66.2	65.6	65.0	64.3	63.8	63.0	62.3	61.5	60.7	59.5	58.7	57.8	56.7	55.4	54.6	52.6	
3	76.2	Min.	74.2	73.9	73.5	72.9	72.6	72.2	71.6	70.9	70.1	69.5	68.7	67.9	67.0	66.1	64.8	63.9	62.9	61.7	60.3	59.4	57.2	
		Nom.	74.4	74.1	73.7	73.3	72.9	72.5	72.0	71.4	70.7	70.1	69.4	68.7	67.8	67.1	65.9	65.0	64.1	63.0	61.8	61.0	58.9	
3-1/4	82.6	Min.	80.6	80.2	79.8	79.3	78.9	78.5	77.9	77.2	76.5	75.8	75.1	74.3	73.3	72.5	71.2	70.3	69.2	68.1	66.7	65.8	63.6	
		Nom.	80.8	80.4	80.1	79.6	79.2	78.9	78.3	77.7	77.0	76.5	75.7	75.0	74.2	73.4	72.2	71.4	70.5	69.4	68.1	67.3	65.3	
3-1/2	88.9	Min.	86.9	86.6	86.2	85.6	85.3	84.9	84.3	83.6	82.8	82.2	81.4	80.6	79.7	78.8	77.5	76.6	75.6	74.4	73.0	72.1	69.9	
		Nom.	87.1	86.8	86.4	86.0	85.6	85.2	84.7	84.1	83.4	82.8	82.1	81.4	80.5	79.8	78.6	77.7	76.8	75.7	74.5	73.7	71.6	
3-3/4	95.3	Min.	93.3	92.9	92.5	92.0	91.6	91.2	90.6	89.9	89.2	88.5	87.8	87.0	86.0	85.2	83.9	83.0	81.9	80.8	79.4	78.5	76.3	
		Nom.	93.5	93.1	92.8	92.3	91.9	91.6	91.0	90.4	89.7	89.2	88.4	87.7	86.9	86.1	84.9	84.1	83.2	82.1	80.8	80.0	78.0	
4	101.6	Min.	99.6	99.3	98.9	98.3	98.0	97.6	97.0	96.3	95.5	94.9	94.1	93.3	92.4	91.5	90.2	89.3	88.3	87.1	85.7	84.8	82.6	
		Nom.	99.8	99.5	99.1	98.7	98.3	97.9	97.4	96.8	96.1	95.5	94.8	94.1	93.2	92.5	91.3	90.4	89.5	88.4	87.2	86.4	84.3	
4-1/2	114.3	Min.	112.3	112.0	111.6	111.0	110.7	110.3	109.7	109.0	108.2	107.6	106.8	106.0	105.1	104.2	102.9	102.0	101.0	99.8	98.4	97.5	95.3	
		Nom.	112.5	112.2	111.8	111.4	111.0	110.6	110.1	109.5	108.8	108.2	107.5	106.8	105.9	105.2	104.0	103.1	102.2	101.1	99.9	99.1	97.0	
5	127.0	Min.	125.0	124.7	124.3	123.7	123.4	123.0	122.4	121.7	120.9	120.3	119.5	118.7	117.8	116.9	115.6	114.7	113.7	112.5	111.1	110.2	108.0	
		Nom.	125.2	124.9	124.5	124.1	123.7	123.3	122.8	122.2	121.5	120.9	120.2	119.5	118.6	117.9	116.7	115.8	114.9	113.8	112.6	111.8	109.7	

## ADDITIONAL BIRMINGHAM WIRE GAGES

NUMBER	36	35	34	33	32	31	30	29	28	27	26	25	24	23	22	21	00	000	0000	00000
MM	.1	.1	.2	.2	.2	.3	.3	.3	.4	.4	.5	.5	.6	.6	.7	.8	9.7	10.8	11.5	12.7



## AMERICAN STANDARD WELDED AND SEAMLESS STEEL PIPE

PIPE			PIPE SCHEDULES (ALL DIMENSIONS IN INCHES)													DBLE. EX. HVY.
SIZE	O.D.	WALL I.D.	5	10	20	30	STAN- DARD	40	60	EX. HVY.	80	100	120	140	160	
1/8	.405	Wall I.D.	.035 .335	.049 .307				.068 .269			.095 .215					
1/4	.540	Wall I.D.	.049 .442	.065 .410				.088 .364			.119 .302					
3/8	.675	Wall I.D.	.049 .577	.065 .545				.091 .493			.126 .423					
1/2	.840	Wall I.D.	.065 .710	.083 .674				.109 .622			.147 .546				.187 .466	.294 .252
3/4	1.050	Wall I.D.	.065 .920	.083 .884				.113 .824			.154 .742				.218 .614	.308 .434
1	1.315	Wall I.D.	.065 1.185	.109 1.097				.133 1.049			.179 .957				.250 .815	.358 .599
1-1/4	1.660	Wall I.D.	.065 1.530	.109 1.442				.140 1.380			.191 1.278				.250 1.160	.382 .896
1-1/2	1.900	Wall I.D.	.065 1.770	.109 1.682				.145 1.610			.200 1.500				.281 1.338	.400 1.100
2	2.375	Wall I.D.	.065 2.245	.109 2.157				.154 2.067			.218 1.939				.343 1.689	.436 1.503
2-1/2	2.875	Wall I.D.	.083 2.709	.120 2.635				.203 2.469			.276 2.323				.375 2.125	.552 1.771
3	3.500	Wall I.D.	.083 3.334	.120 3.260				.216 3.068			.300 2.900				.438 2.624	.600 2.300
3-1/2	4.000	Wall I.D.	.083 3.834	.120 3.760				.226 3.548			.318 3.364					.636 2.728
4	4.500	Wall I.D.	.083 4.334	.120 4.260				.237 4.026	.218 4.064		.337 3.826		.438 3.624		.531 3.438	.674 3.152
4-1/2	5.000	Wall I.D.		.134 4.732				.247 4.506			.355 4.290					.710 3.580
5	5.563	Wall I.D.	.109 5.345	.134 5.295				.258 5.047			.375 4.813		.500 4.563		.625 4.313	.750 4.063
6	6.625	Wall I.D.	.109 6.407	.134 6.357		.250 6.125		.280 6.065			.432 5.761		.562 5.501		.718 5.189	.864 4.897
7	7.625	Wall I.D.						.301 7.023			.500 6.625					.875 5.875
8	8.625	Wall I.D.	.109 8.407	.148 8.329	.250 8.125	.277 8.071		.322 7.981	.406 7.813		.500 7.625	.593 7.439	.718 7.189	.812 7.001	.906 6.813	.875 6.875
10	10.750	Wall I.D.	.134 10.482	.165 10.420	.250 10.250	.307 10.136		.365 10.020	.500 9.750	.500 9.750	.593 9.564	.718 9.314	.843 9.064	1.000 8.750	1.125 8.500	
12	12.750	Wall I.D.	.165 12.420	.180 12.390	.250 12.250	.330 12.090	.375 12.000	.406 11.938	.562 11.626	.500 11.750	.687 11.376	.843 11.064	1.000 10.750	1.125 10.500	1.312 10.126	
14	14.000	Wall I.D.		.250 13.500	.312 13.376	.375 13.250	.375 13.250	.437 13.126	.594 12.812	.500 13.000	.750 12.500	.937 12.126	1.094 11.812	1.250 11.500	1.406 11.188	
16	16.000	Wall I.D.		.250 15.500	.312 15.376	.375 15.250	.375 15.250	.500 15.000	.656 14.688	.500 15.000	.843 14.314	1.031 13.938	1.218 13.564	1.437 13.126	1.593 12.814	
18	18.000	Wall I.D.		.250 17.500	.312 17.376	.438 17.124	.375 17.250	.562 16.876	.750 16.500	.500 17.000	.937 16.126	1.156 15.688	1.375 15.250	1.562 14.876	1.781 14.438	
20	20.000	Wall I.D.		.250 19.500	.375 19.250	.500 19.000	.375 19.250	.593 18.814	.812 18.376	.500 19.000	1.031 17.938	1.280 17.440	1.500 17.000	1.750 16.500	1.968 16.064	
24	24.000	Wall I.D.		.250 23.500	.375 23.250	.562 22.876	.375 23.250	.687 22.626	.969 22.062	.500 23.000	1.218 21.564	1.531 20.938	1.812 20.376	2.062 19.876	2.343 19.314	

## MILLIMETER/INCH AND DECIMAL/FRACTION CONVERSIONS

Inches		Milli- meters	Inches		Milli- meters	Inches		Milli- meters	Inches		Milli- meters
Fractions	Decimals		Fractions	Decimals		Fractions	Decimals		Fractions	Decimals	
1/64	.015625	.397	17/64	.265625	6.747	33/64	.515625	13.097	49/64	.765625	19.447
	.03125	.794		.28125	7.144		.53125	13.494		.78125	19.844
3/64	.046875	1.191	19/64	.296875	7.541	35/64	.546875	13.891	51/64	.796875	20.241
	.0625	1.588		.3125	7.938		.5625	14.288		.8125	20.638
5/64	.078125	1.984	21/64	.328125	8.334	37/64	.578125	14.684	53/64	.828125	21.034
	.09375	2.381		.34375	8.731		.59375	15.081		.84375	21.431
7/64	.109375	2.778	23/64	.359375	9.128	39/64	.609375	15.478	55/64	.859375	21.828
	.125	3.175		.375	9.525		.625	15.875		.875	22.225
9/64	.140625	3.572	25/64	.390625	9.922	41/64	.640625	16.272	57/64	.890625	22.622
	.15625	3.969		.40625	10.319		.65625	16.669		.90625	23.019
11/64	.171875	4.366	27/64	.421875	10.716	43/64	.671875	17.066	59/64	.921875	23.416
	.1875	4.763		.4375	11.113		.6875	17.463		.9375	23.813
13/64	.203125	5.159	29/64	.453125	11.509	45/64	.703125	17.859	61/64	.953125	24.209
	.21875	5.556		.46875	11.906		.71875	18.256		.96875	24.606
15/64	.234375	5.953	31/64	.484375	12.303	47/64	.734375	18.653	63/64	.984375	25.003
	.250	6.350		.500	12.700		.750	19.050		1.000	25.400

# Smarter Tools for Smarter Work

## What are Smart Tools?

*Smarter Tools for Smarter Work* is more than just our tag line. We realize that the single largest cost of fabricating, maintaining, repairing, or cleaning a boiler, heat exchanger, or other pressure vessel is labor. That's why we build time-saving, labor-reducing, error-preventing expertise into all of the tools we design, manufacture, sell, service, and support.

The **Wilson Torq-Air Matic™ Expander Drive** is a good example of a *Smart Tool*. It prevents the operator from over-rolling or under-rolling a tube, saving both the material and labor costs of re-rolling under-rolled tubes, or pulling and replacing over-rolled tubes. The **Wilson i.d.mike, Combination Beading Expander**, and the entire line of **Wils-Away™ Tube Cleaning Systems** are "expert" tools that have time-saving, labor-reducing features built into them.

We look forward to the opportunity to help you and your employees *Work Smarter* by using *Smarter Tools* from **Thomas C. Wilson, Inc.**



*Smarter Tools for  
Smarter Work*

## We're in the Solution Business!

Many of the innovative tools offered by **Thomas C. Wilson, Inc.** are the result of a customer who came to us with a problem, and we created a solution. If you have a tube cleaning, tube expanding, or tube cutting, pulling, trimming, facing, or plugging challenge, contact us, and give us the opportunity to suggest or invent a solution.

If you have drawings, you can mail or fax them to us. Or, you can ship us a sample of the tube or device you are attempting to expand, clean, cut, taper, trim, or otherwise work with. Or, you can call us with the specifics of the job facing you, and we'll work with you to find a solution.

Before you call us, here's some of the information you should have:

- What type of vessel (fire tube boiler, condenser, chiller, heat exchanger, etc.) is involved?
- What is the outer diameter (OD) of the tube or tubes?
- What is the gauge (GA) or thickness of the tube wall?
- From what material are the tubes made?
- How many tubes are there?
- What is the thickness of the tube sheet?
- Is compressed air available at the work site?
- What type of electric power (voltage and Hertz) is available?
- If it is a cleaning application, is water available on-site?

*We look forward to hearing from you!*



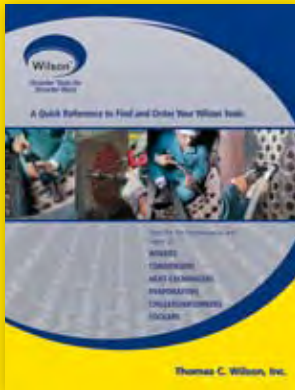

### Quick Reference Catalog

An easy-to-use overview of Wilson's electric and pneumatic tube cleaning systems for heat exchangers, fire tube and water tube boilers, condensers, chillers, and absorbers, as well as other Wilson tools, accessories, and supplies.



### Boiler Tube Expanders and Accessories Catalog

A comprehensive guide to all the tools you need to tube or re-tube water tube or fire tube boilers. Includes pneumatic and electric tube rollers, tube cutters, beading and collapsing tools, as well as tube plugs and accessories.



### Heat Exchanger Tube Expanders and Accessories Catalog

A comprehensive guide to all the tools you need to tube or re-tube condensers, chillers, absorbers, evaporators, and coolers. Includes pneumatic, electric and electronic tube rollers, tube pullers, tubesheet hole tools, tube cutting tools, micrometers, and tube plugs.



**Thomas C. Wilson, Inc.**  
 21-11 44th Avenue  
 Long Island City, New York 11101-5088  
 Telephone: (718) 729-3360  
 Fax: (718) 361-2872  
 Toll Free: (800) 230-2636  
 www.tcwilson.com  
 e-mail: tcwilson@tcwilson.com